



# COVAL

vacuum managers

## CVGC

CARBON Vacuum Grippers



# CVGC

## Carbon Vacuum Grippers

### General Information

With their innovative design, Coval's **CVGC** carbon vacuum grippers correspond perfectly to the weight constraints, flexibility and safety of collaborative robot applications.

The **CVGC** series is composed of:

- a carbon structure, 2.5 times lighter than aluminum and offering mechanical strength 6 times greater
- flexible material on the gripper edges, to protect both gripper and operator
- foam gripping interface, for versatile product handling
- a plastic "function" block, including vacuum generator, pilot control cartridge, silencer and vacuum switch...

... all this, in a very compact and ultralight design, guarantees a fast setup and easy integration on the robot.

The three standard formats allow you to choose your **CVGC** and ensure the handling of your loads: corrugate, plastics, metal/glass plates, etc.



Industry-specific applications

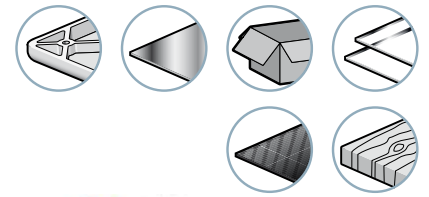

### Advantages

- Ultra-light and compact, due to their carbon design.
- Suitable for collaborative robot applications, heavy-duty robots and special machines.
- Fully integrated, allowing for an easy and fast installation.

### Characteristics

	Dimensions L x W x H (mm)	Air drawn in (SCFM)	Air consumed (SCFM)	Capacity <sup>(1)</sup> (kg)	Weight <sup>(2)</sup> (kg)
<b>CVGC 150X150</b>	150 x 150 x 90	3.18	4.77	30	0.8
<b>CVGC 240X120</b>	240 x 120 x 90	6.36	9.53	38	1.0
<b>CVGC 320X160</b>	320 x 160 x 90	7.42	12.2	68	1.3

(1) Indicative force for a vacuum gripper with foam interface covered 100% by the load, including a safety factor of 2 for horizontal handling and rigid, airtight surface.

(2) Weight indicated for a gripper with A31 or A50 mounting. For a gripper with A63 mounting, add 136 g.

**URCap plugin**  
available for e-Series robots



**UNIVERSAL ROBOTS+**  
Certified

### Applications

The **CVGC** vacuum gripper provide a unique solution for the handling of products in various industrial sectors:

- Packaging
- Plastics
- Metal
- Glass
- Composite
- Wood

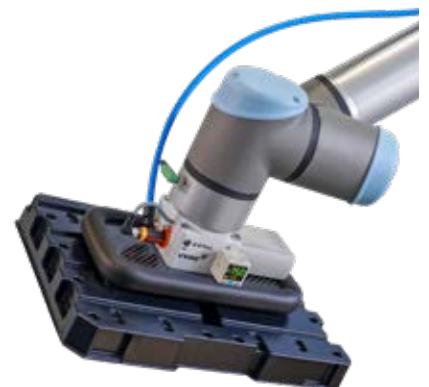

# CVGC

## Carbon Vacuum Grippers

### General Information



#### Ultra-light

Carbon design guarantees strength, rigidity and an unmatched lightness.



#### Vacuum Generator Integrated

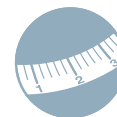

#### 3 Standard Formats

150 x 150 mm  
240 x 120 mm  
320 x 160 mm

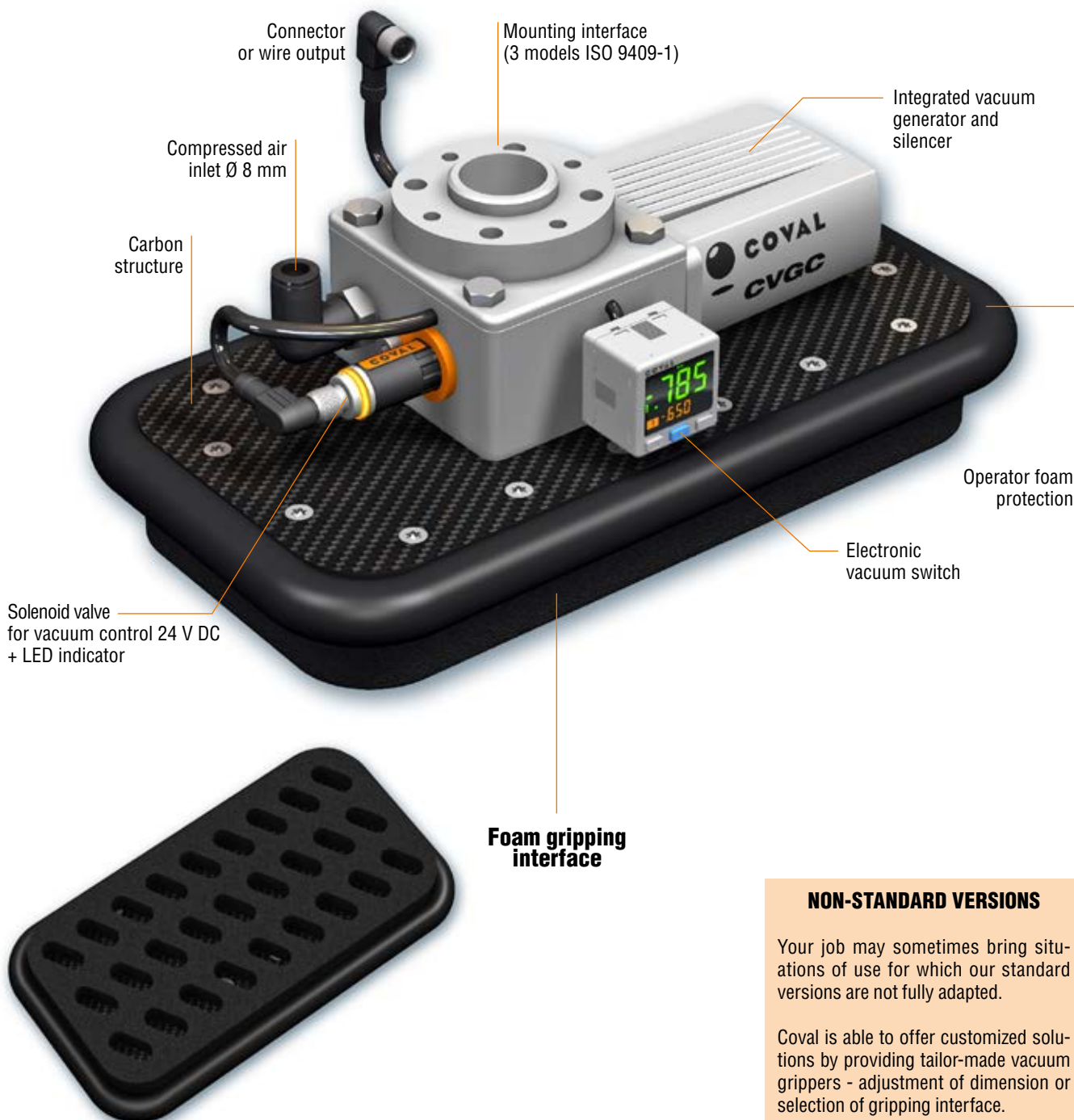

#### NON-STANDARD VERSIONS

Your job may sometimes bring situations of use for which our standard versions are not fully adapted.

Coval is able to offer customized solutions by providing tailor-made vacuum grippers - adjustment of dimension or selection of gripping interface.



### To Order

	<b>CVGC 240X120</b>	<b>A50</b>	<b>C1</b>
<b>DIMENSIONS</b>		<b>ISO 9409-1 ROBOT MOUNTING INTERFACE</b>	<b>ELECTRICAL CONNECTIONS</b>
150 x 150 mm	<b>150X150</b>	<b>A31</b> ISO 9409-1-31.5-4-M5	<b>C1</b> M8 - Female 8-pins
240 x 120 mm	<b>240X120</b>	<b>A50</b> ISO 9409-1-50-4-M6	<b>C2</b> M8 - Male 5-pins
320 x 160 mm	<b>320X160</b>		<b>C3</b> M8 - Male 8-pins
			<b>C4</b> Wire outlet 2 m.
			<b>C5</b> Wire outlet 5 m.
		<b>A63</b> ISO 9409-1-63-4-M6	<b>C6</b> Molex connector 8-pins

### ISO 9409-1 Robot Mounting Interface

Version	Standard	Ø A (mm)	Ø B (mm)	Ø C (mm)	Ø D (mm)	
<b>A31</b>	ISO 9409-1-31.5-4-M5	31.5	40	M5 (4 screws)	5	Fanuc CR-4, CR-7, CR-7 A/L, CR-14 A/L
<b>A50</b>	ISO 9409-1-50-4-M6	50	63	M6 (4 screws)	6	Universal Robots UR3, UR5, UR10, UR16 + e-Series Omron/Techman TM5, TM12, TM14 Doosan Robotics M0609, M1509, M1013, M0617
<b>A63</b>	ISO 9409-1-63-4-M6	63	80	M6 (4 screws)	6	Yaskawa HC10, HC10DT

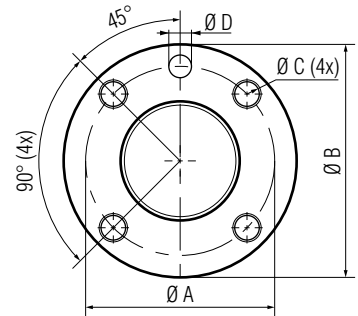

### Electrical Connections

■ **C1:** M8 connector - female 8-pins elbow, cable length 150 mm

Universal Robots CB3 UR3, UR5, UR10 + e-Series UR3e, UR5e, UR10e, UR16e (URCap plugin available)

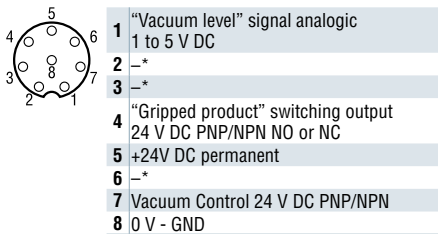

\* not used in this configuration

■ **C2:** M8 connector - male 5-pins elbow, cable length 150 mm

Omron/Techman TM5, TM12, TM14

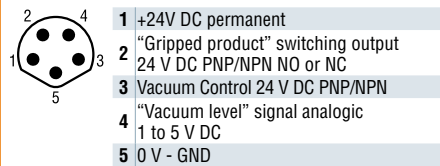

■ **C3:** M8 connector - male 8-pins elbow, cable length 150 mm

Doosan Robotics M0609, M1509, M1013, M0617

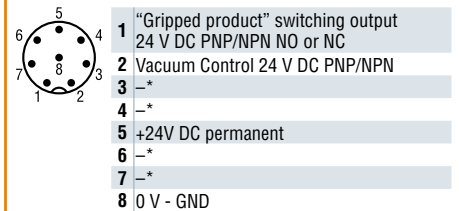

\* not used in this configuration

■ **C4 / C5:** 5-wire output, cable length 2 m (C4) or 5 m (C5)

Fanuc CR-4, CR-7, CR-7, CR-7 A/L, CR-14 A/L + any application requiring cables to be routed outside the robot arm + any robot whose housing connection does not match C1/C2/C3/C6.

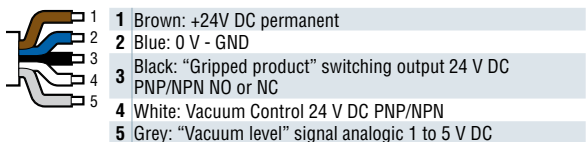

■ **C6:** Molex 8-pole connector, 50 mm long cable.

Yaskawa HC10, HC10DT (+ analog I/O card if required).

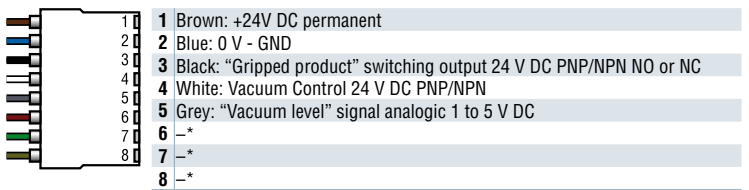

\* not used in this configuration



#### Dimensions

CVGC150X150A

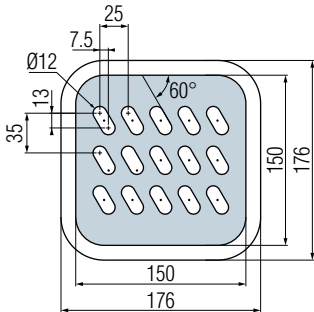

CVGC240X120A

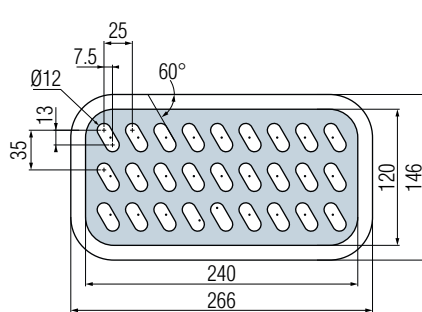

CVGC320X160A

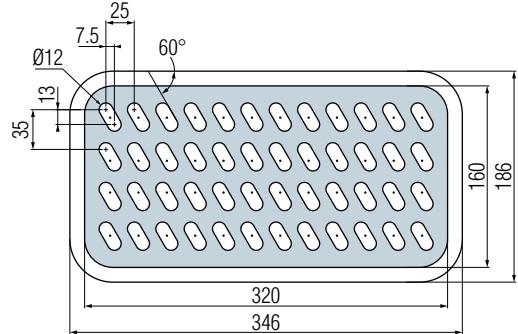

#### Mounting interfaces A31 or A50

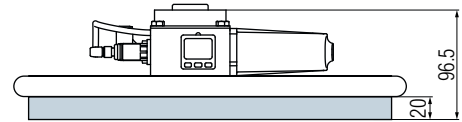
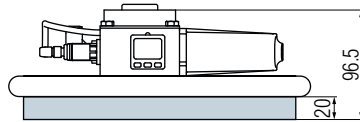
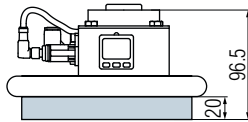

#### Mounting interface A63

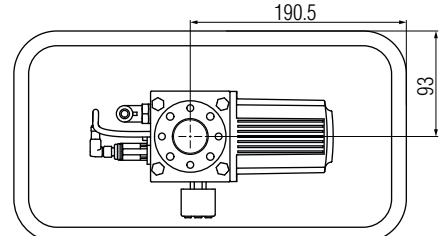
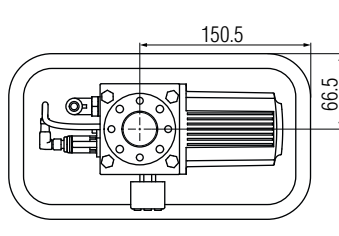
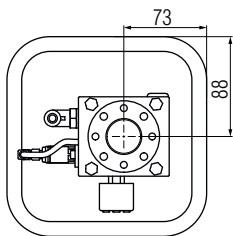
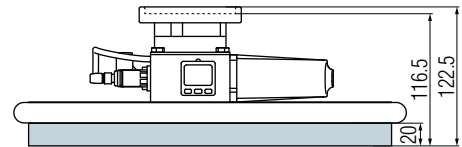
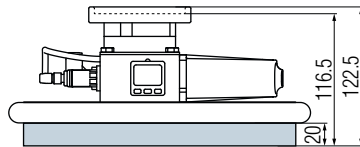
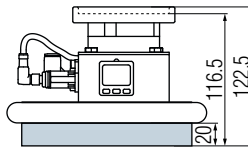

Note: All dimensions are in mm.

#### General Characteristics

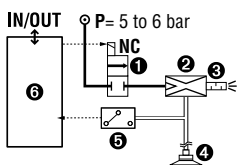

- 1 "Vacuum" solenoid valve
- 2 Venturi
- 3 Through-type silencer
- 4 Foam gripping interface
- 5 Electronic vacuum switch
- 6 Input / Output board

- Supply: non-lubricated air, 5 microns filtered, according to ISO 8573-1:2010 [4:5:4].
- Operating pressure: from 5 to 6 bar
- Optimal pressure:
  - CVGC150x150 / CVGC 320x160: 5.5 bar
  - CVGC240x120: 6 bar
- Maximum vacuum: 85%.
- Vacuum command light: orange LED
- Electric protection grade: IP40
- Control voltage: 24 V DC +/-10%

- Vacuum control: 24 V DC PNP/NPN
- Power consumption: 65 mA (no load)
- The switching type of the inputs / outputs is configurable to PNP or NPN
- Outputs:
  - 1 x "Vacuum level" signal analogic 1 to 5 V DC (depending on robot model, see "Electrical Connections" section)
  - 1 x "Gripped product" switching output 24 V DC PNP/NPN NO or NC (125 mA max.)
- Service life: 30 million cycles
- Operating temperature: from 32 to 122° F
- Materials:
  - Gripper: carbon, PA 6.6 15% FG, brass, stainless steel, PETP
  - Valve: aluminum, steel, NBR
  - Foam gripping interface: EPDM
- Noise level:
  - CVGC 150x150: 72 dBA
  - CVGC 240x120: 71 dBA
  - CVGC 320x160: 66 dBA

The values represent the average characteristics of our products.



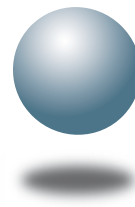

**COVAL**  
vacuum managers

vacuum  
**components**



**A TECHNOLOGICAL PARTNER ON A GLOBAL SCALE**

Located in the southeast region of France, COVAL conceives, manufactures and globally distributes high performance, advanced vacuum automation components and systems for industrial applications in all branches.

COVAL is an ISO 9001: V2015 certified company which offers innovative solutions integrating reliable and optimized components with intelligent functionalities. The focus is to provide the most personalized and economic solution to a given application while assuring a significant improvement in the productivity and the safety for the vacuum users around the world.

COVAL has an ambition for technical excellence and innovation. As a specialist in vacuum automation, COVAL is reputed for offering reliable, personalized, cost effective and productive solutions.

The references of COVAL can be found in several industrial sectors (Packaging, Automotive Industry, Plastic, Graphic, Aeronautic...) where vacuum handling is important for high efficiency and productivity.

COVAL markets its products and services all over Europe, in the United States and South America through its subsidiaries and authorized distribution network. COVAL strives to provide customer driven solutions and gives the best possible treatment to satisfy all its clients.

*For all enquiries from Australia, Africa and Asia kindly contact COVAL head office in France.*



**COVAL S.A.S.**  
Head Office



**COVAL INC.**



**COVAL IBERICA**



**COVAL GERMANY**



**COVAL ITALIA**



**COVAL CHINA**

Distributed by:



certified quality  
management system

**COVAL VACUUM TECHNOLOGY INC.**  
901 Jones Franklin Road  
Suite 100  
Raleigh, NC 27606  
Phone : (919) 233-4855  
Fax : (919) 233-4854

[www.coval-inc.com](http://www.coval-inc.com)