



Operation **Manual**

UMI-B5 UL Series Inverter



www.unitronicsPLC.com

Preface

Thanks for choosing our products.

UMI-B5 UL series inverters are high performance open loop vector inverters for controlling asynchronous AC induction motors and permanent magnet synchronous motors. Applying the most advanced non-velocity sensor vector control technology which keeps pace with the leading international technology and DSP control system, our products enhances its reliability to meet the adaptability to the environment, customized and industrialized design with more optimized functions, more flexible application and more stable performance.

The control performance of UMI-B5 UL series inverters is as outstanding as that of the leading sophisticated inverters on worldwide market. UMI-B5 UL series inverters integrate the drive of asynchronous motors and synchronous motors, torque control and speed control, meeting the high performance requirement of the customer applications and stepping on the unique incorporated inverters with superexcellent control functions in this circle. Simultaneously, comparing with the other kinds, UMI-B5 UL series inverters can adapt to worse grid, temperature, humidity and dust with a better performance of anti-tripping and improved reliability.

UMI-B5 UL series inverters apply modularized design to meet the specific demand of customers, as well as the demand of the whole industry flexibly and follow the trend of industrial application to the inverters on the premise of meeting general need of the market. Powerful speed control, torque control, simple PLC, flexible input/output terminals, pulse frequency given, traverse control can realize various complicate high-accuracy drives and provide integrative solution for the manufacturers of industrial devices, which contributes a lot to the cost reducing and improves reliability.

UMI-B5 UL series inverters can meet the demand of environmental protection which focuses on low noise and weakening electromagnetic interference in the application sites for the customers.

This manual provides installation and configuration, parameters setting, fault diagnoses and daily maintenance and related precautions to customers. Read this manual carefully before the installation to ensure a proper installation and operation and high performance of UMI-B5 UL series inverters.

If the product is ultimately used for military affairs or manufacture of weapon, it will be listed on the export control formulated by Foreign Trade Law of the People's Republic of China. Rigorous review and necessary export formalities are needed when exported.

Our company reserves the right to update the information of our products.

Contents

Preface	i
Contents	ii
1 Safety precautions	1
1.1 What this chapter contains	1
1.2 Safety definition	1
1.3 Warning symbols	1
1.4 Safety guidelines	2
2 Quick start-up	5
2.1 What this chapter contains	5
2.2 Unpacking inspection	5
2.3 Application confirmation	5
2.4 Environment	5
2.5 Installation confirmation	6
2.6 Basic commissioning	6
3 Product overview	7
3.1 What this chapter contains	7
3.2 Basic principles	7
3.3 Product specification	8
3.4 Name plate	10
3.5 Type designation key	10
3.6 Structure diagram	11
4 Installation guide	12
4.1 What this chapter contains	12
4.2 Mechanical installation	12
4.3 Standard wiring	18
4.4 Layout protection	25
5 Keypad operation procedure	27
5.1 What this chapter contains	27
5.2 Keypad	27
5.3 Keypad displaying	29
5.4 Keypad operation	30
6 Function parameters	32
6.1 What this chapter contains	32
6.2 UMI-B5 UL function parameters	32
7 Basic operation instruction	106
7.1 What this chapter contains	106
7.2 First powering on	106
7.3 Vector control	110
7.4 SVPWM control	114
7.5 Torque control	118
7.6 Parameters of the motor	121
7.7 Start-up and stop control	125
7.8 Frequency setting	129

7.9 Analog input	134
7.10 Analog output	136
7.11 Digital input	139
7.12 Digital output	146
7.13 Simple PLC	150
7.14 Multi-step speed running	152
7.15 PID control	154
7.16 Traverse running	158
7.17 Pulse counter	159
7.18 Fixed-length control	160
7.19 Fault procedure	161
8 Fault tracking	164
8.1 What this chapter contains	164
8.2 Alarm and fault indications	164
8.3 How to reset	164
8.4 Fault history	164
8.5 Fault instruction and solution	164
8.6 Common fault analysis	169
9 Maintenance and hardware diagnosis	174
9.1 What this chapter contains	174
9.2 Maintenance intervals	174
9.3 Cooling fan	176
9.4 Capacitors	177
9.5 Power cable	178
10 Communication protocol	179
10.1 What this chapter contains	179
10.2 Brief instruction to Modbus protocol	179
10.3 Application of the inverter	179
10.4 RTU command code and communication data illustration	184
10.5 Common communication fault	198
Appendix A Technical data	199
A.1 What this chapter contains	199
A.2 Ratings	199
A.3 Grid specifications	201
A.4 Motor connection data	201
A.5 Applicable standards	202
A.6 EMC regulations	202
Appendix B Dimension drawings	204
B.1 What this chapter contains	204
B.2 Keypad structure	204
B.3 Inverter structure	205
B.4 Dimensions for inverters	205
Appendix C Further information	207
C.1 Product and service inquiries	207

1 Safety precautions

1.1 What this chapter contains

Read this manual carefully and follow all safety precautions before moving, installing, operating and servicing the inverter. If ignored, physical injury or death may occur, or damage may occur to the devices.









If any physical injury or death or damage to the devices occurs due to neglect of the safety precautions in the manual, our company will not be responsible for any damages and we are not legally bound in any manner.

1.2 Safety definition





- Danger: Serious physical injury or even death may occur if related requirements are not followed
- Warning: Physical injury or damage to the devices may occur if related requirements are not followed
- Note: Physical hurt may occur if related requirements are not followed
- Qualified electricians: People working on the device should take part in professional electrical and safety training, receive the certification and be familiar with all steps and requirements of installing, commissioning, operating and maintaining the device to avoid any emergency.

1.3 Warning symbols

Warnings caution you about conditions which can result in serious injury or death and/or damage to the equipment, and advice on how to avoid the danger. Following warning symbols are used in this manual:

Symbols	Name	Instruction	Abbreviation
 Danger	Electrical Danger	Serious physical injury or even death may occur if related requirements are not followed.	
 Warning	General danger	Physical injury or damage to the devices may occur if related requirements are not followed.	
 Do not	Electrostatic discharge	Damage to the PCBA board may occur if related requirements are not followed.	
 Hot sides	Hot sides	Sides of the device may become hot. Do not touch.	
Note	Note	Physical hurt may occur if related requirements are not followed.	Note

1.4 Safety guidelines

	<p>◇ Only qualified electricians are allowed to operate on the inverter.</p> <p>◇ Do not carry out any wiring, inspection or components replacement when the power supply is applied. Ensure all input power supplies are disconnected before wiring and checking and always wait for at least the time designated on the inverter or until the DC bus voltage is less than 36V. The table below describes the waiting time:</p> <table border="1" style="margin-left: auto; margin-right: auto;"> <thead> <tr> <th colspan="2">Inverter module</th> <th>Minimum waiting time</th> </tr> </thead> <tbody> <tr> <td style="text-align: center;">220V</td> <td style="text-align: center;">1–75HP (0.75–55kW)</td> <td style="text-align: center;">5 minutes</td> </tr> <tr> <td style="text-align: center;">460V</td> <td style="text-align: center;">2–150HP (1.5–110kW)</td> <td style="text-align: center;">5 minutes</td> </tr> </tbody> </table>	Inverter module		Minimum waiting time	220V	1–75HP (0.75–55kW)	5 minutes	460V	2–150HP (1.5–110kW)	5 minutes
Inverter module		Minimum waiting time								
220V	1–75HP (0.75–55kW)	5 minutes								
460V	2–150HP (1.5–110kW)	5 minutes								
	<p>◇ Do not refit the inverter unless authorized; otherwise fire, electric shock or other injury may occur.</p>									
	<p>◇ The base of the radiator may become hot during running. Do not touch to avoid hurt.</p>									
	<p>◇ The electrical parts and components inside the inverter are electrostatic. Take measurements to avoid electrostatic discharge during related operation.</p>									

1.4.1 Delivery and installation

	<p>◇ Install the inverter on fire-retardant material and keep the inverter away from combustible materials.</p> <p>◇ Connect the braking optional parts (braking resistors, braking units or feedback units) according to the wiring diagram.</p> <p>◇ Do not operate on the inverter if there is any damage or components loss to the inverter.</p> <p>◇ Do not touch the inverter with wet items or body, otherwise electric shock may occur.</p> <p>◇ Solid State motor overload protection reacts when reaches 150% of FLA.</p> <p>◇ Drives have no provision for motor over temperature protection.</p>
---	--

Note:

- ◇ Select appropriate moving and installing tools to ensure a safe and normal running of the inverter and avoid physical injury or death. For physical safety, the erector should take some mechanical protective measurements, such as wearing exposure shoes and working uniforms.
- ◇ Ensure to avoid physical shock or vibration during delivery and installation.
- ◇ Do not carry the inverter by its cover. The cover may fall off.
- ◇ Install away from children and other public places.
- ◇ The inverter cannot meet the requirements of low voltage protection in IEC61800-5-1 if the altitude of installation site is above 6562 ft (2000 m).

- ◇ Use the inverter on appropriate condition (See chapter **Installation Environment**).
- ◇ Don't allow screws, cables and other conductive items to fall inside the inverter.
- ◇ The leakage current of the inverter may be above 3.5mA during operation. Proper and reliable grounding is essential before connecting to power supply. Ground with proper techniques and ensure the grounding resistance is less than 10Ω. The conductivity of PE grounding conductor is the same as that of the phase conductor (with the same cross sectional area).
- ◇ R, S and T are the input terminals of the power supply, while U, V and W are the motor terminals. Connect the input power cables and motor cables with proper techniques; otherwise the damage to the inverter may occur.

1.4.2 Commissioning and running

	<ul style="list-style-type: none"> ◇ Disconnect all power supplies applied to the inverter before the terminal wiring and wait for at least the designated time after disconnecting the power supply. ◇ High voltage is present inside the inverter during running. Do not carry out any operation except for the keypad setting. ◇ The inverter may start up by itself when P01.21=1. Do not get close to the inverter and motor. ◇ The inverter cannot be used as “Emergency-stop device”. ◇ The inverter cannot be used to break the motor suddenly. A mechanical braking device should be provided. ◇ Besides the above items, check to ensure the following ones before the installation and maintenance during the running of the permanent synchronous motor: <ol style="list-style-type: none"> 1. All input power supplies are disconnected (including the main power supply and the control power supply). 2. The permanent magnet synchronous motor has stopped running and measured to ensure the output voltage of the inverter is less than 36V. 3. The waiting time of the permanent magnet synchronous motor after stopping is no less than the time designated and measure to ensure the voltage between + and – is less than 36V. 4. Ensure the permanent magnet synchronous motor does not rotate again because of the external load. It is recommended to install effectively external braking devices or disconnect the electric wiring between the motor and the inverter directly.
---	--

Note:

- ◇ Do not switch on or off the input power supply of the inverter frequently.
- ◇ For inverters that have been stored for a long time, check and fix the capacitance and try to run it again before utilization (see **Maintenance and Hardware Fault Diagnose**).
- ◇ Cover the front board before running, otherwise electric shock may occur.

1.4.3 Maintenance and replacement of components

	<ul style="list-style-type: none"> ✧ Only qualified electricians are allowed to perform the maintenance, inspection, and components replacement of the inverter. ✧ Disconnect all power supplies to the inverter before the terminal wiring. Wait for at least the time designated on the inverter after disconnection. ✧ Take measures to avoid screws, cables and other conductive matters to fall into the inverter during maintenance and component replacement.
---	---

Note:

- ✧ Select proper torque to tighten screws.
- ✧ Keep the inverter, parts and components away from combustible materials during maintenance and component replacement.
- ✧ Do not carry out any isolation and pressure test on the inverter and do not measure the control circuit of the inverter by megameter.
- ✧ Carry out a sound anti-electrostatic protection to the inverter and its internal components during maintenance and component replacement.

1.4.4 What to do after scrapping

	<p>There are heavy metals in the inverter. Deal with it as industrial effluent.</p>
---	---

2 Quick start-up

2.1 What this chapter contains

This chapter mainly describes the basic guidelines during the installation and commissioning procedures on the inverter, which you may follow to install and commissioning the inverter quickly.

2.2 Unpacking inspection

Check as follows after receiving products:

- | |
|---|
| 1. Check whether the packing box is damaged or dampened. If yes, contact local dealers or UNITRONICS offices. |
| 2. Check the model identifier on the exterior surface of the packing box is consistent with the purchased model. If no, contact local dealers or UNITRONICS offices. |
| 3. Check whether the interior surface of packing box is abnormal, for example, in wet condition, or whether the enclosure of the inverter is damaged or cracked. If yes, contact local dealers or UNITRONICS offices. |
| 4. Check whether the name plate of the inverter is consistent with the model identifier on the exterior surface of the packing box. If no, contact local dealers or UNITRONICS offices. |
| 5. Check whether the accessories (including user's manual and control keypad) inside the packing box are complete. If no, contact local dealers or UNITRONICS offices. |

2.3 Application confirmation

Check the machine before beginning to use the inverter:

- | |
|---|
| 1. Check the load type to verify that there is no overload of the inverter during work and check that whether the drive needs to modify the power degree. |
| 2. Check that the actual current of the motor is less than the rated current of the inverter. |
| 3. Check that the control accuracy of the load is the same of the inverter. |
| 4. Check that the incoming supply voltage is correspondent to the rated voltage of the inverter. |
| 5. Check that the communication needs option card or not. |

2.4 Environment

Check as follows before the actual installation and usage:

- | |
|--|
| 1. Check that the ambient temperature of the inverter is below 104°F (40°C). If exceeds, derate according to the detailed information of Appendix B. Additionally, the inverter cannot be used if the ambient temperature is above 122°F (50°C).
Note: For the cabinet inverter, the ambient temperature means the air temperature inside the cabinet. |
| 2. Check that the ambient temperature of the inverter in actual usage is above 14°F (-10°C). If no, add heating facilities.
Note: For the cabinet inverter, the ambient temperature means the air temperature inside the cabinet. |
| 3. Check that the altitude of the actual usage site is below 3281ft (1000m). If exceeds, derate 1% for every additional 328ft (100m). |

4. Check that the humidity of the actual usage site is below 90% and condensation is not allowed. If no, add additional protection inverters.
5. Check that the actual usage site is away from direct sunlight and foreign objects cannot enter the inverter. If no, add additional protective measures.
6. Check that there is no conductive dust or flammable gas in the actual usage site. If no, add additional protection to inverters.

2.5 Installation confirmation

Check as follows after the installation:

1. Check that the load range of the input and output cables meet the need of actual load.
2. Check that the accessories of the inverter are correctly and properly installed. The installation cables should meet the needs of every component (including reactors, input filters, output reactors, output filters, DC reactors, braking units and braking resistors).
3. Check that the inverter is installed on non-flammable materials and the calorific accessories (reactors and brake resistors) are away from flammable materials.
4. Check that all control cables and power cables are run separately and the routing complies with EMC requirement.
5. Check that all grounding systems are properly grounded according to the requirements of the inverter.
6. Check that the free space during installation is sufficient according to the instructions in user's manual.
7. Check that the installation conforms to the instructions in user's manual. The drive must be installed in an upright position.
8. Check that the external connection terminals are tightly fastened and the torque is appropriate.
9. Check that there are no screws, cables and other conductive items left in the inverter. If no, get them out.

2.6 Basic commissioning

Complete the basic commissioning as follows before actual utilization:

1. Select the motor type, set correct motor parameters and select control mode of the inverter according to the actual motor parameters.
2. Autotune. If possible, de-coupled from the motor load to start dynamic autotune. Or if no, static autotune is available.
3. Adjust the ACC/DEC time according to the actual running of the load.
4. Commissioning the device via jogging and check that the rotation direction is as required. If no, change the rotation direction by changing the wiring of motor.
5. Set all control parameters and then operate.

3 Product overview

3.1 What this chapter contains

The chapter briefly describes the operation principle, product characteristics, layout, name plate and type designation information.

3.2 Basic principles

UMI-B5 UL series inverters are wall or flange mountable devices for controlling asynchronous AC induction motors and permanent magnet synchronous motors.

The diagram below shows the simplified main circuit diagram of the inverter. The rectifier converts three-phase AC voltage to DC voltage. The capacitor bank of the intermediate circuit stabilizes the DC voltage. The converter transforms the DC voltage back to AC voltage for the AC motor. The brake pipe connects the external braking resistor to the intermediate DC circuit to consume the feedback energy when the voltage in the circuit exceeds its maximum limit.

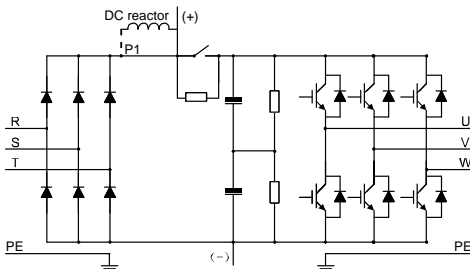

Figure 3-1 Main circuit of inverters of 220V, 25–75HP (18.5–55kW) and 460V, ≥50HP (37kW)

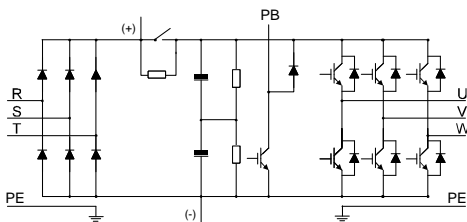

Figure 3-2 Main circuit of inverters of 220V, ≤20HP (15kW) and 460V, ≤40HP (30kW)

Note:

1. The inverters of 220V 25–75HP (18.5–55kW) and 460V ≥ 50HP (37kW) supports external DC reactors and external braking units, but it is necessary to remove the copper tag between P1 and (+) before connecting. DC reactors and external braking units are optional.
2. The inverters of 220V ≤ 20HP (15kW), 460V ≤ 40HP (30kW) supports external braking resistors which are optional.

3.3 Product specification

Function		Specification
Power input	Input voltage (V)	AC 1PH 200V–240V, rated voltage: 220V AC 3PH 200V–240V, rated voltage: 220V AC 3PH 380V–480V, rated voltage: 460V
	Allowable Voltage Fluctuation	-15%→+10%
	Input current (A)	Refer to <i>the rated value</i>
	Input frequency (Hz)	50Hz or 60Hz Allowed range: 47–63Hz
Power output	Output voltage (V)	0–input voltage
	Output current (A)	Refer to <i>the rated value</i>
	Output power HP (kW)	Refer to <i>the rated value</i>
	Output frequency (Hz)	0–400Hz
Technical control feature	Control mode	SVPWM, sensorless vector control
	Motor type	Asynchronous motor and permanent magnet synchronous motor
	Adjustable-speed ratio	Asynchronous motor 1:200 (SVC) synchronous motor 1:20 (SVC)
	Speed control accuracy	±0.2% (sensorless vector control)
	Speed fluctuation	± 0.3% (sensorless vector control)
	Torque response	<20ms (sensorless vector control)
	Torque control accuracy	10% (sensorless vector control)
	Starting torque	Asynchronous motor: 0.25Hz/150% (SVC) Synchronous motor: 2.5 Hz/150% (SVC)
Running control feature	Frequency setting method	Digital setting, analog setting, pulse frequency setting, multi-step speed running setting, simple PLC setting, PID setting, MODBUS communication setting, PROFIBUS communication setting. Switch between the combination and single setting channel.
	Auto-adjustment of the voltage	Keep constant voltage automatically when the grid voltage transients
	Fault protection	Provide more than 30 fault protection functions: overcurrent, overvoltage, undervoltage, overheating, phase loss and overload, etc.

Function		Specification
	Restart after rotating speed tracking	Smooth starting of the rotating motor
Peripheral interface	Terminal analog input resolution	≤ 20mV
	Terminal switch input resolution	≤ 2ms
	Analog input	2 (AI1, AI2) 0–10V/0–20mA and 1 (AI3) -10–10V
	Analog output	2 (AO1, AO2) 0–10V /0–20mA
	Digital input	8 common inputs, the max frequency: 1kHz, internal impedance: 3.3kΩ; 1 high speed input, the max frequency: 50kHz
	Digital output	1 high speed pulse output, the max frequency: 50kHz; 1 Y terminal open collector output
	Relay output	2 programmable relay outputs RO1A NO, RO1B NC, RO1C common terminal RO2A NO, RO2B NC, RO2C common terminal Contactor capability: 3A/AC250V, 1A/DC30V
Others	Mountable method	Wall and flange mounting
	Temperature of the running environment	14–122°F (-10–50°C), derate 1% for every additional 1.8°F above 104°F (40°C)
	Average non-fault time	2 years (77°F (25°C) ambient temperature)
	Cooling	Air-cooling
	Braking unit	Built-in for inverters of 220V ≤ 20HP (15kW) and 460V, ≤ 40HP (30kW) optional for inverters of 220V 25–75HP (18.5–55kW) and 460V, ≥50HP (37kW)
	EMC filter	The inverters of 460V have built-in C3 filters: meet the degree requirement of IEC61800-3 C3
	Oversvoltage category	For input voltage 220-240V: transient surge suppression shall be installed on the line side of this equipment and shall be rated 220V (phase to ground), 220V (phase to phase), suitable for oversvoltage category III, and shall provide protection for a rated impulse withstand voltage peak of 4kV. For input voltage 323-480V: transient surge suppression shall be installed on the line side of this equipment and shall be rated 480V (phase to ground), 480V (phase to phase), suitable for oversvoltage category III, and shall provide protection for a rated impulse withstand voltage peak of 6kV.

3.4 Name plate

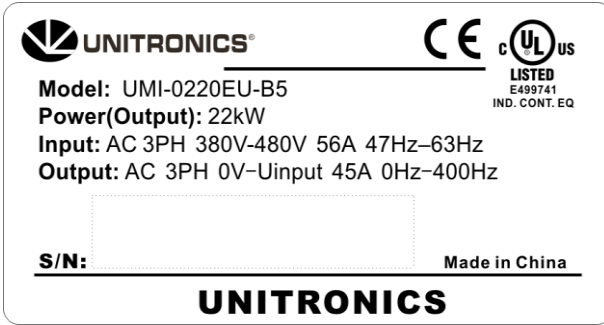

Figure 3-3 Name plate

3.5 Type designation key

The type designation contains information on the inverter. The user can find the type designation on the type designation label attached to the inverter or the simple name plate.

UMI - 0550 - E - U - B - B5
 ① ② ③ ④ ⑤ ⑥

Figure 3-4 Product type

Key	No.	Detailed description	Detailed content
Product line	①	Abbreviation for product line	UMI for Unitronics Inverters
Rated power	②	Power Range	0015: 1.5kW(2HP) 0550: 55kW(75HP)
Voltage degree	③	Voltage degree	B: 1PH 200V-240V C: 3PH 200V-240V E: 3PH 380V-480V
Certification	④	Certification	U: UL
Optional Braking unit	⑤	Optional Braking unit	B: Built-in braking unit. Optional for models ≥ 60 HP (45kW)
Product series	⑥	Product series	B5: for B5 Series Inverter Family

3.6 Structure diagram

Figure 3-5 is the layout figure of the inverter (take the inverter of 460V 40HP (30kW) as the example).

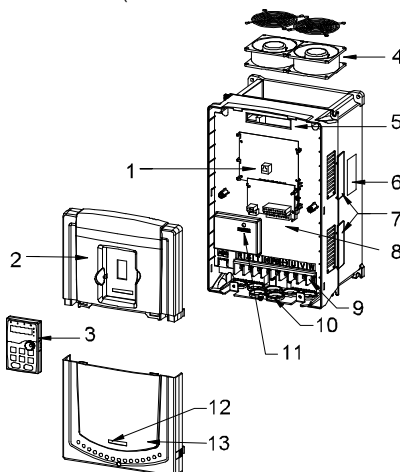



Figure 3-5 Product structure

Serial No.	Name	Illustration
1	Keypad port	Connect the keypad
2	Upper cover	Protect the internal parts and components
3	Keypad	See Keypad Operation Procedure for detailed information
4	Cooling fan	See Maintenance and Hardware Fault Diagnose for detailed information
5	Wiring port	Connect to the control board and the drive board
6	Name plate	See Product Overview for detailed information
7	Side cover	Optional. The side cover will increase the protective degree of the inverter. The internal temperature of the inverter will increase, too, so it is necessary to derate the inverter at the same time
8	Control terminals	See Electric Installation for detailed information
9	Main circuit terminals	See Electric Installation for detailed information
10	Main circuit cable port	Fix the main circuit cable
11	POWER light	Power indicator
12	Simple name plate	See Model codes for detailed information
13	Lower cover	Protect the internal parts and components

4 Installation guide

4.1 What this chapter contains

The chapter describes the mechanical installation and electric installation.

	<ul style="list-style-type: none"> ◇ Only qualified electricians are allowed to carry out what described in this chapter. Operate as the instructions in Safety Precautions. Ignoring these may cause physical injury or death or damage to the devices. ◇ Ensure the power supply of the inverter is disconnected during the operation. Wait for at least the time designated until the POWER indicator is off after the disconnection if the power supply is applied. It is recommended to use the multimeter to monitor that the DC bus voltage of the drive is under 36V. ◇ The installation and design of the inverter should be complied with the requirement of the local laws and regulations in the installation site. If the installation infringes the requirement, our company will exempt from any responsibility. Additionally, if users do not comply with the suggestion, some damage beyond the assured maintenance range may occur.
---	---

4.2 Mechanical installation

4.2.1 Installation environment

The installation environment is the safeguard for a full performance and long-term stable functions of the inverter. Check the installation environment as follows:

Environment	Conditions
Installation site	Indoor
Environment temperature	<p>14–122°F (-10–+50°C)</p> <p>If the ambient temperature of the inverter is above 104°F (40°C), derate according to the detailed information of Appendix B.</p> <p>It is not recommended to use the inverter if ambient temperature is above 122°F (50°C).</p> <p>In order to improve the reliability of the device, do not use the inverter if the ambient temperature changes frequently.</p> <p>Provide cooling fan or air conditioner to control the internal ambient temperature below the required one if the inverter is used in a closed space such as in the control cabinet.</p> <p>When the temperature is too low, if the inverter needs to restart to run after a long stop, it is necessary to provide an external heating device to increase the internal temperature, otherwise damage to the devices may occur.</p>
Humidity	<p>RH≤90%</p> <p>No condensation is allowed.</p> <p>The max relative humidity should be equal to or less than 60% in corrosive air.</p>

Environment	Conditions
Storage temperature	-22–140°F (-30—+60°C)
Running environment condition	The installation site of the inverter should: keep away from the electromagnetic radiation source; keep away from contaminative air, such as corrosive gas, oil mist and flammable gas; ensure foreign objects, such as metal power, dust, oil, water cannot enter into the inverter (do not install the inverter on the flammable materials such as wood); keep away from direct sunlight, oil mist, steam and vibration environment.
Altitude	<3281ft (1000m) If the altitude is above 3281ft (1000m), derate 1% for every additional 328ft (100m).
Vibration	≤ 5.88m/s ² (0.6g)
Installation direction	The inverter should be installed on an upright position to ensure sufficient cooling effect.

Note:

- ◆ UMI-B5 UL series inverters should be installed in a clean and ventilated environment according to enclosure classification.
- ◆ Cooling air must be clean, free from corrosive materials and electrically conductive dust.

4.2.2 Installation direction

The inverter may be installed in a cabinet.

The inverter must be installed in an upright position. Check the installation site according to the requirements below. Refer to chapter *Dimension Drawings* in the appendix for frame details.

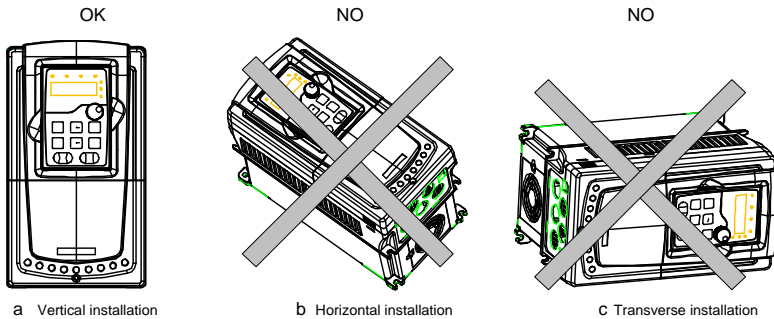

Figure 4-1 Installation direction of the inverter

4.2.3 Installation manner

The inverter can be installed in three different ways, depending on the frame size:

- a) Wall mounting for inverters of 220V, ≤75HP (55kW) and 460V, ≤150HP (110kW)
- b) Flange mounting for inverters of 220V, ≤75HP (55kW) and 460V, ≤150HP (110kW)

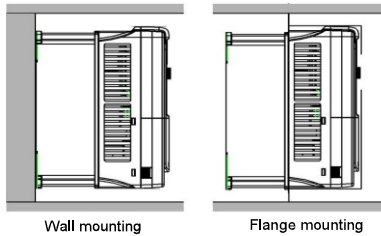

Figure 4-2 Installation manner

- (1) Mark the hole location. The location of the holes is shown in the dimension drawings in the appendix C.
- (2) Fix the screws or bolts to the marked locations.
- (3) Put the inverter against the wall.
- (4) Tighten the screws in the wall securely.

Note:

Flange installation for inverters of 220V, 1–20HP (0.75–15kW) and 460V, 2–40HP (1.5–30kW) needs flange board, while flange installation for inverters of 220V, 25–75HP (18.5–55kW) and 460V, 50–150HP (37kW-110kW) needs no flange board.

4.2.4 Single installation

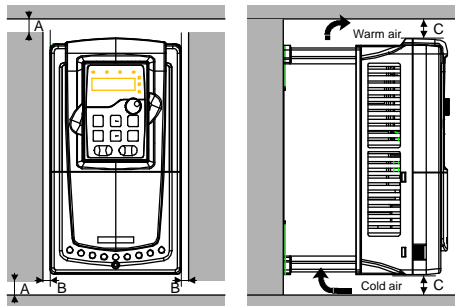

Figure 4-3 Single installation

Note: The minimum space of B and C is 100 mm.

4.2.5 Multiple installations

Parallel installation

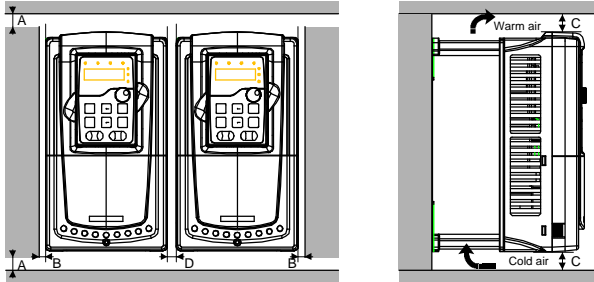

Figure 4-4 Parallel installation

Note:

- ◆ Before installing the different sizes inverters, align their top position for the convenience of later maintenance.
- ◆ The minimum space of B, D and C is 100 mm.

4.2.6 Vertical installation

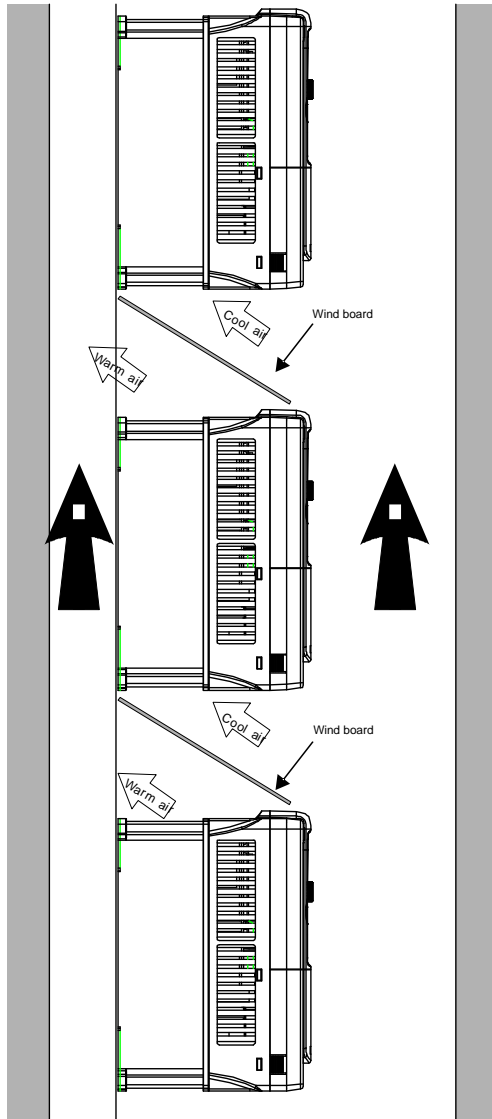

Figure 4-5 Vertical installation

Note: Windscreen should be installed in vertical installation for avoiding mutual impact and insufficient cooling.

4.2.7 Slanting installation

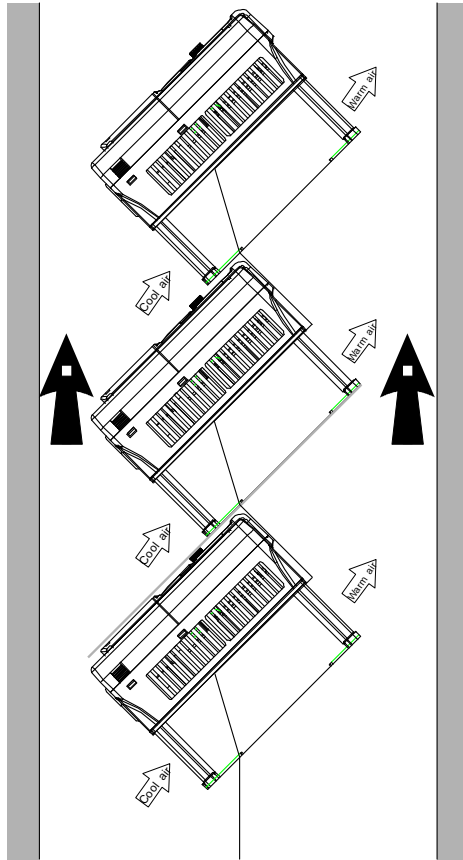

Figure 4-6 Slanting installation

Note: Ensure the separation of the wind input and output channels in slanting installation for avoiding mutual impact.

4.3 Standard wiring

4.3.1 Connection diagram of main circuit

Connection diagram of main circuit for the inverters of AC 3PH 380V–480V

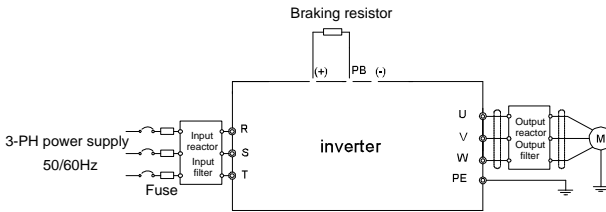

Figure 4-7 Connection diagram of main circuit of inverters of 220V, ≤20HP (15kW) and 460V, ≤40HP (30kW)

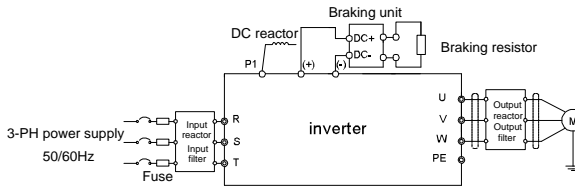

Figure 4-8 Connection diagram of main circuit of inverters of 220V, 25–75HP (18.5–55kW) and 460V, ≥50HP (37kW)

Note:

- ◆ The fuse, DC reactor, braking unit, braking resistor, input reactor, input filter, output reactor, output filter are optional parts. Refer to **Peripheral Optional Parts** for detailed information.
- ◆ **P1** and **(+)** are short circuited in factory for the inverters of 220V, ≥ 25HP (18.5kW) and 460V, ≥50HP (37kW), if you need to connect with the DC reactor, remove the contact tag between **P1** and **(+)**.
- ◆ Remove the yellow warning labels of **PB**, **(+)** and **(-)** on the terminals before connecting the braking resistor; otherwise, poor connection may occur.

4.3.2 Terminals figure of main circuit

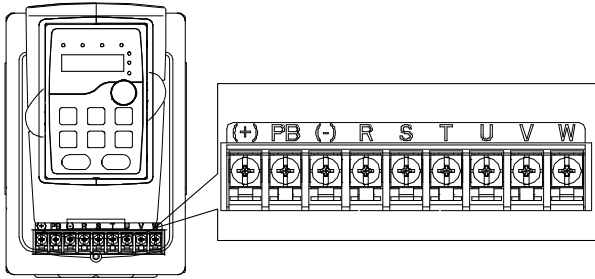

Figure 4-9 Terminals of main circuit of inverters of 220V, 1HP (0.75kW) and 460V, 2–3HP (1.5–2.2kW)

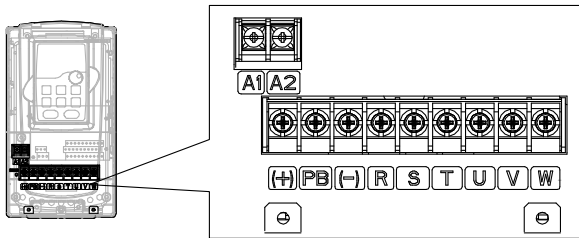

Figure 4-10 Terminals of main circuit of inverters of 220V, 2–3HP (1.5–2.2kW) and 460V, 5–7.5HP (4–5.5kW)

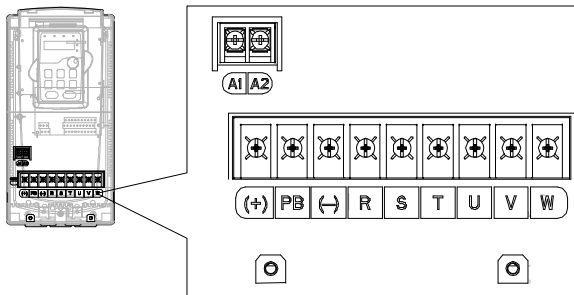

Figure 4-11 Terminals of main circuit of inverters of 220V, 5–7.5HP (4–5.5kW) and 460V, 10–15HP (7.5–11kW)

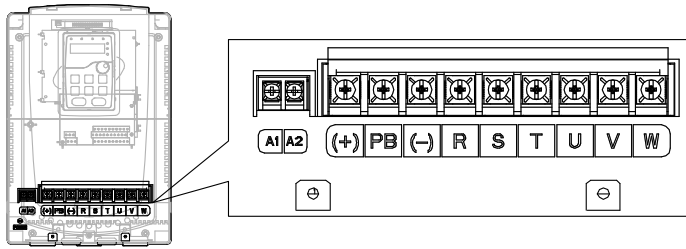

Figure 4-12 Terminals of main circuit of inverters of 220V, 10HP (7.5kW) and 460V, 20–25HP (15–18.5kW)

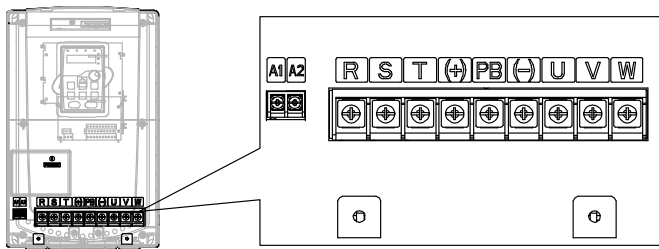

Figure 4-13 Terminals of main circuit of inverters of 220V, 15–20HP (11–15kW) and 460V, 30–40HP (22–30kW)

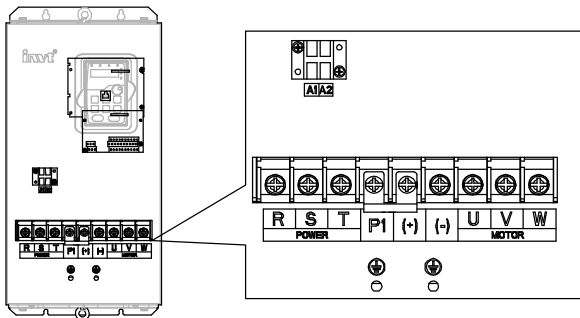

Figure 4-14 Terminals of main circuit of inverters of 220V, 25–40HP (18.5–30kW), and 460V, 50–75HP (37–55kW)

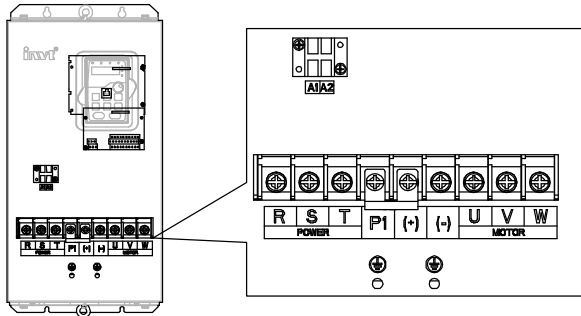

Figure 4-15 Terminals of main circuit of inverters of 220V, 50–75HP (37–55kW) and 460V, 100–150HP (75–110kW)

Terminal	220V ≤20HP (15kW) 460V ≤40H(30kW)	220V, ≥25HP (18.5kW)	Function
		460V, ≥ 50HP (37kW)	
R, S, T	Power input of the main circuit		3-phase AC input terminals which are generally connected with the power supply.
U, V, W	The inverter output		3-phase AC output terminals which are generally connected with the motor.
P1	/	DC reactor terminal 1	P1 and (+) are connected with the terminals of DC reactor. (+) and (-) are connected with the terminals of braking unit.
(+)	Braking resistor 1	DC reactor terminal 2, braking unit terminal 1	
(-)	/	Braking unit terminal 2	PB and (+) are connected with the terminals of braking resistor.
PB	Braking resistor 2	/	
PE	460V: the grounding resistance is less than 10Ohm		Protective grounding terminals, every machine is provided 2 PE terminals as the standard configuration. These terminals should be grounded with proper techniques.
A1 and A2	Control power supply terminal		Optional parts (external 220V control power supply)

Note:

- ◆ Do not use an asymmetrically constructed motor cable. If there is a symmetrically constructed grounding conductor in the motor cable in addition to the conductive shield, connect the grounding conductor to the grounding terminal at the inverter and motor ends.
- ◆ Braking resistor, braking unit and DC reactor are optional parts.
- ◆ Route the motor cable, input power cable and control cables separately.

- ◆ If the terminal description is “/”, the machine does not provide the terminal as the external terminal.

4.3.3 Wiring of terminals in main circuit

1. Connect the ground line of input power cable to the ground terminal of inverter (PE) directly, and connect 3PH input cable to R, S and T and fasten up.
2. Connect the ground line of motor cable to the ground terminal of the inverter, and connect the 3PH motor cable to U, V, W and fasten up.
3. Connect the brake resistor which carries cables to the designated position.
4. Fasten up all the cables on the outside of the inverter if allowed.

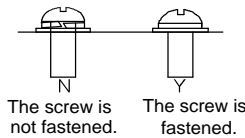

Figure 4-16 Correct installation of the screw

4.3.4 Wiring diagram of control circuit

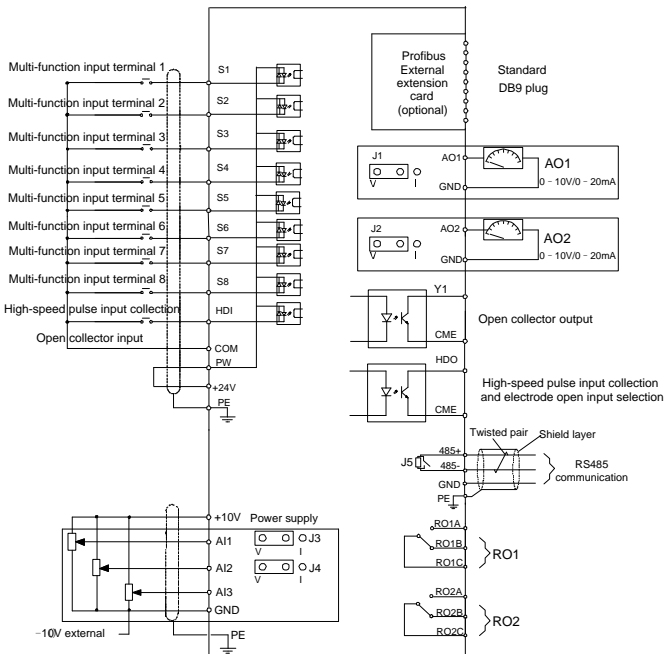

Figure 4-17 Wiring of control circuit

4.3.5 Terminals of control circuit

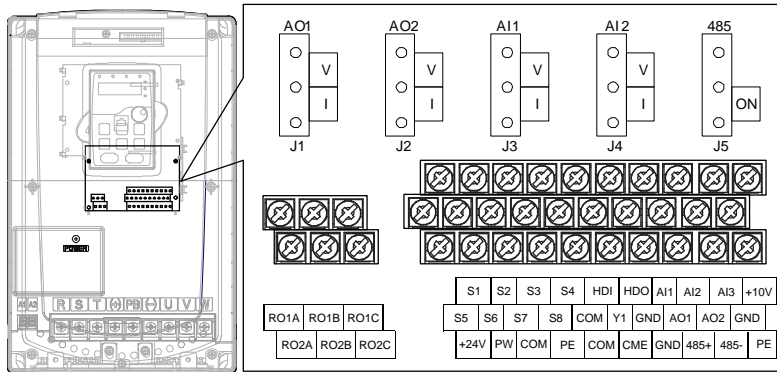

Figure 4-18 Terminals of control circuit

Terminal name	Description
+10V	Local power supply +10V
AI1	1. Input range: AI1/AI2 voltage and current can be chosen: 0–10V/0–20mA; AI1 can be shifted by J3; AI2 can be shifted by J4
AI2	AI3: -10V–+10V
AI3	2. Input impedance: voltage input: 20kΩ; current input: 500Ω
GND	3. Resolution: the minimum one is 5mV when 10V corresponds to 60Hz
AO1	4. Deviation ±1%, 77°F (25°C)
AO2	+10V reference null potential
RO1A	1. Output range: 0–10V or 0–20mA
RO1B	2. The voltage or the current output is depended on the jumper
RO1C	3. Deviation ±1%, 77°F (25°C)
RO2A	RO1 relay output, RO1A NO, RO1B NC, RO1C common terminal
RO2B	Contactor capability: 3A/AC250V, 1A/DC30V
RO2C	RO2 relay output, RO2A NO, RO2B NC, RO2C common terminal
PE	Contactor capability: 3A/AC250V, 1A/DC30V
PW	Grounding terminal
24V	Provide the input switch working power supply from external to internal.
COM	Voltage range: 12–24V
S1	The inverter provides the power supply for users with a max output current of 200mA
S5	+24V common terminal
S1	Switch input 1 1. Internal impedance: 3.3kΩ

Terminal name	Description	
S2	Switch input 2	2. 12–30V voltage input is available 3. The terminal is the dual-direction input terminal supporting both NPN and PNP 4. Max input frequency: 1kHz 5. All are programmable digital input terminal. User can set the terminal function through function codes.
S3	Switch input 3	
S4	Switch input 4	
S5	Switch input 5	
S6	Switch input 6	
S7	Switch input 7	
S8	Switch input 8	
HDI	Except for S1–S8, this terminal can be used as high frequency input channel. Max. input frequency: 50kHz	
HDO	1. Switch input: 200mA/30V 2. Output frequency range: 0–50kHz	
COM	+24V common terminal	
CME	Common terminal of the open collector pole output	
Y1	1. Switch capability: 200mA/30V 2. Output frequency range: 0–1kHz	
485+	RS485 communication interface.	
485-	In order to ensure stable communication channel: <ul style="list-style-type: none"> • Use shielded twisted pair cable. • Connect the HOST RS485 signal ground to one of the VFD CMD/GND terminals. • Connect one of the CMD/GND terminals to PE terminal. • Earth the cable shield to the PE terminal. 	

4.3.6 Input /Output signal connection figure

Use U-shaped contact tag to set NPN mode or PNP mode and the internal or external power supply. The default setting is NPN internal mode.

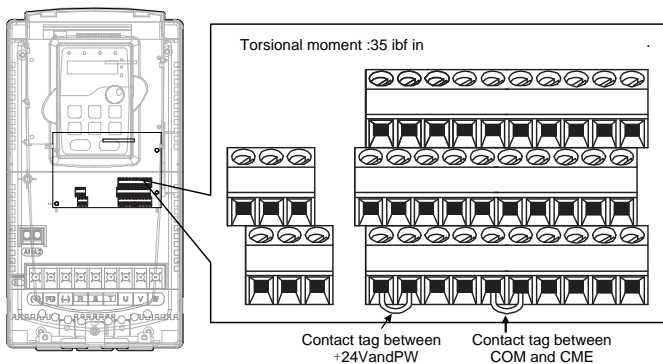

Figure 4-19 U-shaped contact tag

If the signal is from NPN transistor, set the U-shaped contact tag between +24V and PW as below according to the used power supply.

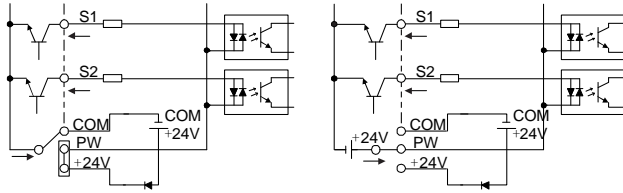

Figure 4-20 NPN modes

If the signal is from PNP transistor, set the U-shaped contact tag as below according to the used power supply.

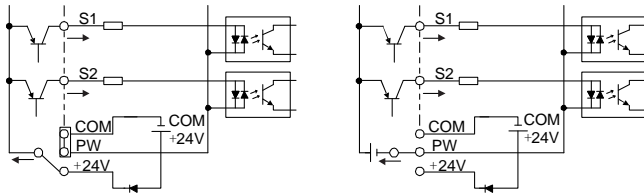

Figure 4-21 PNP modes

4.4 Layout protection

4.4.1 Protecting the inverter and input power cable in short-circuit situations

Protect the inverter and input power cable in short circuit situations and against thermal overload.

Arrange the protection according to the following guidelines.

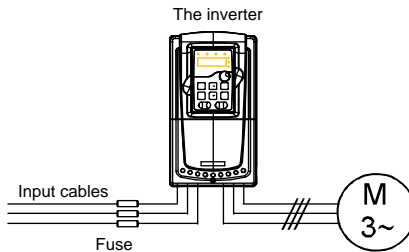

Figure 4-22 Fuse configuration

Note: Select the fuse as the manual indicated. The fuse will protect the input power cable from damage in short-circuit situations. It will protect the surrounding devices when the internal of the inverter is short circuited.

4.4.2 Protecting the motor and motor cable in short-circuit situations

The inverter protects the motor and motor cable in a short-circuit situation when the motor cable is dimensioned according to the rated inverter current. No additional protection devices are needed.



⚡ If the inverter is connected to multiple motors, a separate thermal overload switch or a circuit breaker must be used for protecting each cable and motor. These devices may require a separate fuse to cut off the short-circuit current.

4.4.3 Protecting the motor against thermal overload

According to regulations, the motor must be protected against thermal overload and the current must be switched off when overload is detected. The inverter includes a motor thermal protection function that protects the motor and closes the output to switch off the current when necessary.

4.4.4 Implementing a bypass connection

It is necessary to set power frequency and variable frequency conversion circuits for the assurance of continuous normal work of the inverter if faults occur in some significant situations.

In some special situations, for example, if it is only used in soft start, the inverter can be converted into power frequency running after starting and some corresponding bypass should be added.



⚡ Never connect the supply power to the inverter output terminals U, V and W. Power line voltage applied to the output can result in permanent damage to the inverter.

If frequent shifting is required, employ mechanically connected switches or contactors to ensure that the motor terminals are not connected to the AC power line and inverter output terminals simultaneously.

5 Keypad operation procedure

5.1 What this chapter contains

This chapter contains following operation:

Buttons, indicating lights and the screen as well as the methods to inspect, modify and set function codes by keypad

5.2 Keypad

The keypad is used to control UMI-B5 UL series inverters, read the state data and adjust parameters.

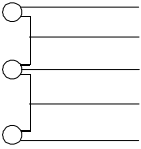









Figure 5-1 Keypad

Note:

1. The LED keypad is standard but the LCD keypad which can support various languages, parameters copy and 10-line displaying is optional.
2. It is necessary to use M3 screw or installation bracket to fix the external keypad. The installation bracket for inverters of 220V, 1–20HP (0.75–15kW) and 460V, 2–40HP (1.5–30kW) is optional but it is standard for the inverters of 460V, 50–150HP (37–110kW).

No.	Name	Description
1	State LED	<p>RUN/TUNE</p> <p>LED off means that the inverter is in the stopping state; LED blinking means the inverter is in the parameter autotune state; LED on means the inverter is in the running state.</p>
		<p>FWD/REV</p> <p>FED/REV LED</p> <p>LED off means the inverter is in the forward rotation state; LED on means the inverter is in the reverse rotation state</p>
		<p>LOCAL/REMOT</p> <p>LED for keypad operation, terminals operation and</p>

No.	Name	Description																																																																					
			remote communication control LED off means that the inverter is in the keypad operation state; LED blinking means the inverter is in the terminals operation state; LED on means the inverter is in the remote communication control state.																																																																				
		TRIP	LED for faults LED on when the inverter is in the fault state; LED off in normal state; LED blinking means the inverter is in the pre-alarm state.																																																																				
2	Unit LED	Mean the unit displayed currently																																																																					
			Hz RPM A % V	Frequency unit Rotating speed unit Current unit Percentage Voltage unit																																																																			
3	Code displaying zone	5-figure LED display displays various monitoring data and alarm code such as set frequency and output frequency.																																																																					
		<table border="1"> <thead> <tr> <th>Displayed character</th> <th>Corresponding character</th> <th>Displayed character</th> <th>Corresponding character</th> <th>Displayed character</th> <th>Corresponding character</th> </tr> </thead> <tbody> <tr> <td style="text-align: center;">0</td> <td style="text-align: center;">0</td> <td style="text-align: center;">1</td> <td style="text-align: center;">1</td> <td style="text-align: center;">2</td> <td style="text-align: center;">2</td> </tr> <tr> <td style="text-align: center;">3</td> <td style="text-align: center;">3</td> <td style="text-align: center;">4</td> <td style="text-align: center;">4</td> <td style="text-align: center;">5</td> <td style="text-align: center;">5</td> </tr> <tr> <td style="text-align: center;">6</td> <td style="text-align: center;">6</td> <td style="text-align: center;">7</td> <td style="text-align: center;">7</td> <td style="text-align: center;">8</td> <td style="text-align: center;">8</td> </tr> <tr> <td style="text-align: center;">9</td> <td style="text-align: center;">9</td> <td style="text-align: center;">A</td> <td style="text-align: center;">A</td> <td style="text-align: center;">b</td> <td style="text-align: center;">b</td> </tr> <tr> <td style="text-align: center;">C</td> <td style="text-align: center;">C</td> <td style="text-align: center;">d</td> <td style="text-align: center;">d</td> <td style="text-align: center;">E</td> <td style="text-align: center;">E</td> </tr> <tr> <td style="text-align: center;">F</td> <td style="text-align: center;">F</td> <td style="text-align: center;">H</td> <td style="text-align: center;">H</td> <td style="text-align: center;">I</td> <td style="text-align: center;">I</td> </tr> <tr> <td style="text-align: center;">L</td> <td style="text-align: center;">L</td> <td style="text-align: center;">N</td> <td style="text-align: center;">N</td> <td style="text-align: center;">n</td> <td style="text-align: center;">n</td> </tr> <tr> <td style="text-align: center;">O</td> <td style="text-align: center;">O</td> <td style="text-align: center;">P</td> <td style="text-align: center;">P</td> <td style="text-align: center;">r</td> <td style="text-align: center;">r</td> </tr> <tr> <td style="text-align: center;">S</td> <td style="text-align: center;">S</td> <td style="text-align: center;">t</td> <td style="text-align: center;">t</td> <td style="text-align: center;">U</td> <td style="text-align: center;">U</td> </tr> <tr> <td style="text-align: center;">v</td> <td style="text-align: center;">V</td> <td style="text-align: center;">.</td> <td style="text-align: center;">.</td> <td style="text-align: center;">-</td> <td style="text-align: center;">-</td> </tr> </tbody> </table>	Displayed character	Corresponding character	Displayed character	Corresponding character	Displayed character	Corresponding character	0	0	1	1	2	2	3	3	4	4	5	5	6	6	7	7	8	8	9	9	A	A	b	b	C	C	d	d	E	E	F	F	H	H	I	I	L	L	N	N	n	n	O	O	P	P	r	r	S	S	t	t	U	U	v	V	.	.	-	-			
		Displayed character	Corresponding character	Displayed character	Corresponding character	Displayed character	Corresponding character																																																																
		0	0	1	1	2	2																																																																
		3	3	4	4	5	5																																																																
		6	6	7	7	8	8																																																																
		9	9	A	A	b	b																																																																
		C	C	d	d	E	E																																																																
		F	F	H	H	I	I																																																																
		L	L	N	N	n	n																																																																
O	O	P	P	r	r																																																																		
S	S	t	t	U	U																																																																		
v	V	.	.	-	-																																																																		
4	Digital potentiometer	Tuning frequency. Refer to P08.41.																																																																					
5	Buttons		Programming key	Enter or escape from the first level menu and remove the parameter quickly																																																																			
			Entry key	Enter the menu step-by-step Confirm parameters																																																																			
			UP key	Increase data or function code progressively																																																																			

No.	Name	Description	
		DOWN key	Decrease data or function code progressively
		Right-shift key	Move right to select the displaying parameter circularly in stopping and running mode. Select the parameter modifying digit during the parameter modification
		Run key	This key is used to operate on the inverter in key operation mode
		Stop/Reset key	This key is used to stop in running state and it is limited by function code P07.04 This key is used to reset all control modes in the fault alarm state
		Quick key	The function of this key is confirmed by function code P07.02.



5.3 Keypad displaying

The keypad displaying state of UMI-B5 UL series inverters is divided into stopping state parameter, running state parameter, function code parameter editing state and fault alarm state and so on.



5.3.1 Displayed state of stopping parameter

When the inverter is in the stopping state, the keypad will display stopping parameters which is shown in Figure 5-2.

In the stopping state, various kinds of parameters can be displayed. Select the parameters to be displayed or not by P07.07. See the instructions of P07.07 for the detailed definition of each bit.

In the stopping state, there are 14 stopping parameters can be selected to be displayed or not. They are: set frequency, bus voltage, input terminals state, output terminals state, PID given value, PID feedback value, torque set value, AI1, AI2, AI3, HDI, PLC and the current stage of multi-step speeds, pulse counting value, length value. P07.07 can select the parameter to be displayed or not by bit and  /SHIFT can shift the parameters from left to right,  (P07.02=2) can shift the parameters from right to left.

5.3.2 Displayed state of running parameters

After the inverter receives valid running commands, the inverter will enter into the running state and the keypad will display the running parameters.  LED on the keypad is on, while the  is determined by the current running direction which is shown in Figure 5-2.

In the running state, there are 24 parameters can be selected to be displayed or not. They are: running frequency, set frequency, bus voltage, output voltage, output torque, PID given value, PID feedback value, input terminals state, output terminals state, torque set value, length value, PLC and the current stage of multi-step speeds, pulse counting value, AI1, AI2, AI3, HDI, percentage of motor overload, percentage of inverter overload, ramp given value, linear speed, AC input current. P07.05

and P07.06 can select the parameter to be displayed or not by bit and **▶/SHIFT** can shift the parameters from left to right, **QUICK/JOG**(P07.02=2) can shift the parameters from right to left.

5.3.3 Displayed state of fault

If the inverter detects the fault signal, it will enter into the fault pre-alarm displaying state. The keypad will display the fault code by flicking. The **TRIP** LED on the keypad is on, and the fault reset can be operated by the **STOP/RST** on the keypad, control terminals or communication commands.

5.3.4 Displayed state of function codes editing

In the state of stopping, running or fault, press **PRG/ESC** to enter into the editing state (if there is a password, see P07.00).The editing state is displayed on two classes of menu, and the order is: function code group/function code number→function code parameter, press **DATA/ENT** into the displayed state of function parameter. On this state, you can press **DATA/ENT** to save the parameters or press **PRG/ESC** to retreat.

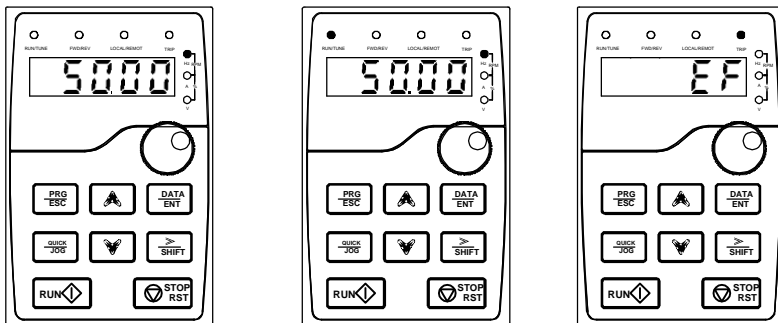

Figure 5-2 Displayed state

5.4 Keypad operation

Operate the inverter via operation panel. See the detailed structure description of function codes in the brief diagram of function codes.

5.4.1 How to modify the function codes of the inverter

The inverter has three levels menu, which are:

1. Group number of function code (first-level menu)
2. Tab of function code (second-level menu)
3. Set value of function code (third-level menu)

Remarks: Press both the **PRG/ESC** and the **DATA/ENT** can return to the second-level menu from the third-level menu. The difference is: pressing **DATA/ENT** will save the set parameters into the control panel, and then return to the second-level menu with shifting to the next function code automatically; while pressing **PRG/ESC** will directly return to the second-level menu without saving the parameters, and keep staying at the current function code.

Under the third-level menu, if the parameter has no flickering bit, it means the function code cannot be

modified. The possible reasons could be:

- 1) This function code is not modifiable parameter, such as actual detected parameter, operation records and so on;
- 2) This function code is not modifiable in running state, but modifiable in stop state.

Example: Set function code P00.01 from 0 to 1.

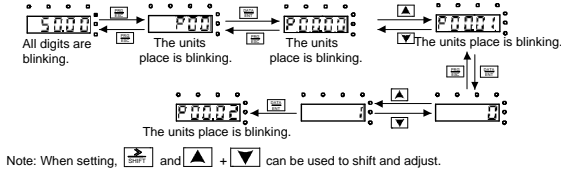

Figure 5-3 Sketch map of modifying parameters

5.4.2 How to set the password of the inverter

UMI-B5 UL series inverters provide password protection function to users. Set P7.00 to gain the password and the password protection becomes valid instantly after quitting from the function code editing state. Press again to the function code editing state, "0.0.0.0.0" will be displayed. Unless using the correct password, the operators cannot enter it.

Set P7.00 to 0 to cancel password protection function.

The password protection becomes effective instantly after retreating from the function code editing state. Press again to the function code editing state, "0.0.0.0.0" will be displayed. Unless using the correct password, the operators cannot enter it.

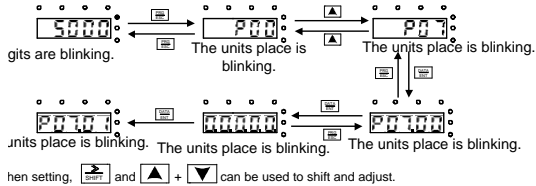

Figure 5-4 Sketch map of password setting

5.4.3 How to watch the inverter state through function codes

UMI-B5 UL series inverters provide group P17 as the state inspection group. Users can enter into P17 directly to watch the state.

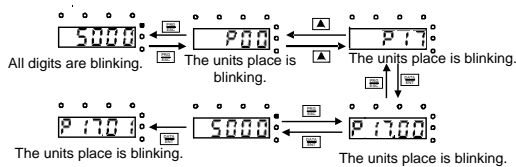

Figure 5-5 Sketch map of state watching

6 Function parameters

6.1 What this chapter contains

This chapter lists and describes the function parameters.

6.2 UMI-B5 UL function parameters

The function parameters of UMI-B5 UL series inverters have been divided into 30 groups (P00–P29) according to the function, of which P18–P28 are reserved. Each function group contains certain function codes applying 3-level menus. For example, “P08.08” means the eighth function code in the P8 group function, P29 group is factory reserved, and users are forbidden to access these parameters.

For the convenience of function codes setting, the function group number corresponds to the first level menu, the function code corresponds to the second level menu and the function code corresponds to the third level menu.

1. Below is the instruction of the function lists:

The first line “Function code”: codes of function parameter group and parameters;

The second line “Name”: full name of function parameters;

The third line “Detailed instruction of parameters”: detailed illustration of the function parameters

The fourth line “Default value”: the original factory values of the function parameter;

The fifth line “Modify”: the modifying character of function codes (the parameters can be modified or not and the modifying conditions), below is the instruction:

“○”: means the set value of the parameter can be modified on stop and running state;

“◉”: means the set value of the parameter cannot be modified on the running state;

“●”: means the value of the parameter is the real detection value which cannot be modified.

(The inverter has limited the automatic inspection of the modifying character of the parameters to help users avoid mis-modification)

2. “Parameter radix” is decimal (DEC), if the parameter is expressed by hex, then the parameter is separated from each other when editing. Setting range of certain bits are 0–F (hex).

3. “The default value” means the function parameter will restore to the default value during default parameters restoring. But the detected parameter or recorded value won’t be restored.

4. For a better parameter protection, the inverter provides password protection to the parameters. After setting the password (set P07.00 to any non-zero number), the system will come into the state of password verification firstly after the user press **PRG/ESC** to come into the function code editing state. And then “0.0.0.0.0.” will be displayed. Unless the user input right password, they cannot enter into the system. For the factory setting parameter zone, it needs correct factory password (remind that the users cannot modify the factory parameters by themselves, otherwise, if the parameter setting is incorrect, damage to the inverter may occur). If the password protection is unlocked, the user can modify the password freely and the inverter will work as the last setting one. When P07.00 is set to 0,

the password can be canceled. If P07.00 is not 0 during powering on, then the parameter is protected by the password. When modify the parameters by serial communication, the function of the password follows the above rules, too.

Function code	Name	Detailed instruction of parameters	Default value	Modify
P00 Group Basic function group				
P00.00	Speed control mode	<p>0: Sensorless vector control mode 0 (apply to AM and SM) No need to install encoders. It is suitable in cases with low frequency, big torque and high speed control accuracy for accurate speed and torque control. Relative to mode 1, this mode is more suitable for medium and small power.</p> <p>1: Sensorless vector control mode 1 (applying to AM) No need to install encoders. It is suitable in cases with high speed control accuracy for accurate speed and torque control at all power ratings.</p> <p>2: SVPWM control No need to install encoders. It can improve the control accuracy with the advantages of stable operation, valid low-frequency torque boost and current vibration suppression and the functions of slip compensation and voltage adjustment.</p> <p>Note: AM-Asynchronous motor SM-Synchronous motor</p>	1	⊙
P00.01	Run command channel	<p>Select the run command channel of the inverter. The control command of the inverter includes: start-up, stop, forward, reverse, jogging and fault reset.</p> <p>0: Keypad running command channel ("LOCAL/REMOTE" light off) Carry out the command control by RUN, STOP/RST on the keypad. Set the multi-function key QUICK/JOG to FWD/REV shifting function (P07.02=3) to change the running direction; press RUN and STOP/RST simultaneously in running state to make the inverter coast to stop.</p> <p>1: Terminal running command channel ("LOCAL/REMOTE" flickering) Carry out the running command control by the</p>	0	○

Function code	Name	Detailed instruction of parameters	Default value	Modify
		forward rotation, reverse rotation and forward jogging and reverse jogging of the multi-function terminals 2: Communication running command channel ("LOCAL/REMOTE" on); The running command is controlled by the upper monitor via communication		
P00.02	Communication running commands	Select the controlling communication command channel of the inverter. 0: MODBUS communication channel 1: PROFIBUS/CANopen communication channel 2: Ethernet communication channel 3: Reserved Note: 1, 2 and 3 are extension functions which need corresponding extension cards.	0	<input type="radio"/>
P00.03	Max. output frequency	This parameter is used to set the maximum output frequency of the inverter. Users should pay attention to this parameter because it is the foundation of the frequency setting and the speed of acceleration and deceleration. Setting range: P00.04–400.00Hz	60.00Hz	<input checked="" type="radio"/>
P00.04	Upper limit of the running frequency	The upper limit of the running frequency is the upper limit of the output frequency of the inverter which is lower than or equal to the maximum frequency. Setting range: P00.05–P00.03 (Max. output frequency)	60.00Hz	<input checked="" type="radio"/>
P00.05	Lower limit of the running frequency	The lower limit of the running frequency is that of the output frequency of the inverter. The inverter runs at the lower limit frequency if the set frequency is lower than the lower limit one. Note: Max. output frequency ≥ Upper limit frequency ≥ Lower limit frequency Setting range: 0.00Hz–P00.04 (Upper limit of the running frequency)	0.00Hz	<input checked="" type="radio"/>
P00.06	A frequency command	0: Keypad Modify the value P00.10 (set the frequency by keypad) to modify the frequency by the keypad.	0	<input type="radio"/>
P00.07	B frequency command	1: AI1 2: AI2 3: AI3	2	<input type="radio"/>

Function code	Name	Detailed instruction of parameters	Default value	Modify
		<p>Set the frequency by analog input terminals. UMI-B5 UL series inverters provide 3 ways analog input terminals as the standard configuration, of which AI1/AI2 are the voltage/current option (0–10V/0–20mA) which can be shifted by jumpers; while AI3 is voltage input (-10V→+10V).</p> <p>Note: when analog AI1/AI2 select 0–20mA input, the corresponding voltage of 20mA is 10V.</p> <p>100.0% of the analog input setting corresponds to the maximum frequency (function code P00.03) in forward direction and -100.0% corresponds to the maximum frequency in reverse direction (function code P00.03)</p> <p>4: High-speed pulse HDI setting The frequency is set by high-speed pulse terminals. UMI-B5 UL series inverters provide 1 high speed pulse input as the standard configuration. The pulse frequency range is 0.00–50.00kHz.</p> <p>100.0% of the high speed pulse input setting corresponds to the maximum frequency in forward direction (P00.03) and -100.0% corresponds to the maximum frequency in reverse direction (P00.03).</p> <p>Note: The pulse setting can only be input by multi-function terminals HDI. Set P05.00 (HDI input selection) to high speed pulse input, and set P05.49 (HDI high speed pulse input function selection) to frequency setting input.</p> <p>5: Simple PLC program setting The inverter runs at simple PLC program mode when P00.06=5 or P00.07=5. Set P10 (simple PLC and multi-step speed control) to select the running frequency, running direction, ACC/DEC time and the keeping time of corresponding stage. See the function description of P10 for detailed information.</p> <p>6: Multi-step speed running setting The inverter runs at multi-step speed mode when P00.06=6 or P00.07=6. Set P05 to select the current running stage, and set P10 to select the current running frequency.</p>		

Function code	Name	Detailed instruction of parameters	Default value	Modify
		<p>The multi-step speed has the priority when P00.06 or P00.07 does not equal to 6, but the setting stage can only be the 1–15 stage. The setting stage is 1–15 if P00.06 or P00.07 equals to 6.</p> <p>7: PID control setting The running mode of the inverter is process PID control when P00.06=7 or P00.07=7. It is necessary to set P09. The running frequency of the inverter is the value after PID effect. See P09 for the detailed information of the given source, given value, feedback source of PID.</p> <p>8: MODBUS communication setting The frequency is set by MODBUS communication. See P14 for detailed information.</p> <p>9: PROFIBUS/CANopen communication setting The frequency is set by PROFIBUS/ CANopen communication. See P15 for the detailed information.</p> <p>10: Ethernet communication setting (reserved)</p> <p>11: Reserved</p> <p>Note: A frequency and B frequency cannot set as the same frequency given method.</p>		
P00.08	B frequency command reference	<p>0: Maximum output frequency, 100% of B frequency setting corresponds to the maximum output frequency</p> <p>1: A frequency command, 100% of B frequency setting corresponds to the maximum output frequency. Select this setting if it needs to adjust on the base of A frequency command.</p>	0	○
P00.09	Combination of the setting source	<p>0: A, the current frequency setting is A frequency command</p> <p>1: B, the current frequency setting is B frequency command</p> <p>2: A+B, the current frequency setting is A frequency command + B frequency command</p> <p>3: A-B, the current frequency setting is A frequency command - B frequency command</p> <p>4: Max (A, B): The bigger one between A frequency command and B frequency is the set frequency.</p> <p>5: Min (A, B): The lower one between A frequency</p>	0	○

Function code	Name	Detailed instruction of parameters	Default value	Modify
		command and B frequency is the set frequency. Note: The combination manner can be shifted by P5 (terminal function)		
P00.10	Keypad set frequency	When A and B frequency commands are selected as “keypad setting”, the value of the function code is the original setting one of the frequency data of the inverter. Setting range: 0.00 Hz–P00.03 (the max frequency)	60.00Hz	○
P00.11	ACC time 1	ACC time means the time needed if the inverter speeds up from 0Hz to the max One (P00.03).	Depend on model	○
P00.12	DEC time 1	DEC time means the time needed if the inverter speeds down from the max Output frequency to 0Hz (P00.03). UMI-B5 UL series inverters define four groups of ACC/DEC time which can be selected by P05. The factory default ACC/DEC time of the inverter is the first group. Setting range of P00.11 and P00.12: 0.0–3600.0s	Depend on model	○
P00.13	Running direction	0: Runs at the default direction, the inverter runs in the forward direction. FWD/REV indicator is off. 1: Runs at the reverse direction, the inverter runs in the reverse direction. FWD/REV indicator is on. Modify the function code to shift the rotation direction of the motor. This effect equals to the shifting the rotation direction by adjusting either two of the motor lines (U, V and W). The motor rotation direction can be changed by QUICK/JOG on the keypad. Refer to parameter P07.02. Note: When the function parameter comes back to the default value, the motor’s running direction will come back to the factory default state, too. In some cases it should be used with caution after commissioning if the change of rotation direction is disabled. 2: Forbid to run in reverse direction: It can be used in some special cases if the reverse running is disabled.	0	○

Function code	Name	Detailed instruction of parameters	Default value	Modify																													
P00.14	Carrier frequency setting	<table border="1"> <thead> <tr> <th>Carrier frequency</th> <th>Electro magnetic noise</th> <th>Noise and leakage current</th> <th>Heating eliminating</th> </tr> </thead> <tbody> <tr> <td>1kHz</td> <td>↑ High</td> <td>↑ Low</td> <td>↑ Low</td> </tr> <tr> <td>10kHz</td> <td>↓ Low</td> <td>↓ High</td> <td>↓ High</td> </tr> <tr> <td>15kHz</td> <td></td> <td></td> <td></td> </tr> </tbody> </table> <p>The relationship table of the motor type and carrier frequency:</p> <table border="1"> <thead> <tr> <th colspan="2">Model</th> <th>Factory value of carrier frequency</th> </tr> </thead> <tbody> <tr> <td>220V</td> <td>1-75HP (0.75-55kW)</td> <td>2kHz</td> </tr> <tr> <td rowspan="3">460V</td> <td>2-15HP (1.5-11kW)</td> <td>8kHz</td> </tr> <tr> <td>20-75HP (15-55kW)</td> <td>4kHz</td> </tr> <tr> <td>100-150HP (75-110kW)</td> <td>2kHz</td> </tr> </tbody> </table> <p>The advantage of high carrier frequency: ideal current waveform, little current harmonic wave and motor noise.</p> <p>The disadvantage of high carrier frequency: increasing the switch loss, increasing inverter temperature and the impact to the output capacity.</p> <p>The inverter needs to derate on high carrier frequency. At the same time, the leakage and electrical magnetic interference will increase.</p> <p>Applying low carrier frequency is contrary to the above, too low carrier frequency will cause unstable running, torque decreasing and surge.</p> <p>The manufacturer has set a reasonable carrier frequency when the inverter is in factory. In general, users do not need to change the parameter.</p> <p>When the frequency used exceeds the default carrier frequency, the inverter needs to derate according to the detailed information of Appendix B.</p> <p>Setting range: 1.0-15.0kHz</p>	Carrier frequency	Electro magnetic noise	Noise and leakage current	Heating eliminating	1kHz	↑ High	↑ Low	↑ Low	10kHz	↓ Low	↓ High	↓ High	15kHz				Model		Factory value of carrier frequency	220V	1-75HP (0.75-55kW)	2kHz	460V	2-15HP (1.5-11kW)	8kHz	20-75HP (15-55kW)	4kHz	100-150HP (75-110kW)	2kHz	Depend on model	○
Carrier frequency	Electro magnetic noise	Noise and leakage current	Heating eliminating																														
1kHz	↑ High	↑ Low	↑ Low																														
10kHz	↓ Low	↓ High	↓ High																														
15kHz																																	
Model		Factory value of carrier frequency																															
220V	1-75HP (0.75-55kW)	2kHz																															
460V	2-15HP (1.5-11kW)	8kHz																															
	20-75HP (15-55kW)	4kHz																															
	100-150HP (75-110kW)	2kHz																															
P00.15	Motor parameter autotuning	<p>0: No operation</p> <p>1: Rotating autotuning</p> <p>Comprehensive motor parameter autotune</p> <p>It is recommended to use Rotating autotuning when</p>	0	◎																													

Function code	Name	Detailed instruction of parameters	Default value	Modify
		high control accuracy is needed. 2: Static autotuning 1 (autotune totally); It is suitable in the cases when the motor cannot de-couple from the load. The autotuning for the motor parameter will impact the control accuracy. 3: Static autotuning 2 (autotune part parameters); when the current motor is motor 1, autotune P02.06, P02.07, P02.08; and when the current motor is motor 2, autotune P12.06, P12.07, P12.08.		
P00.16	AVR function selection	0: Invalid 1: Valid during the whole procedure The auto-adjusting function of the inverter can cancel the impact on the output voltage of the inverter because of the bus voltage fluctuation.	1	○
P00.17	Reserved		0	◎
P00.18	Function restore parameter	0: No operation 1: Restore the default value 2: Cancel the fault record Note: The function code will restore to 0 after finishing the operation of the selected function code. Restoring to the default value will cancel the user password, use this function with caution.	0	◎
P01 Group Start-up and stop control				
P01.00	Start mode	0: Start-up directly: start from the starting frequency P01.01 1: Start-up after DC braking: start the motor from the starting frequency after DC braking (set the parameter P01.03 and P01.04). It is suitable in the cases where reverse rotation may occur to the low inertia load during starting. 2: Start-up after speed tracing: start the rotating motor smoothly after tracking the rotation speed and direction automatically. It is suitable in the cases where reverse rotation may occur to the big inertia load during starting.	0	◎
P01.01	Starting frequency of direct start	Starting frequency of direct start-up means the original frequency during the inverter starting. See P01.02 for detailed information.	0.50Hz	◎

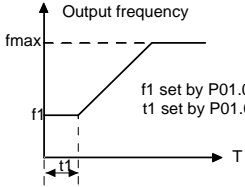
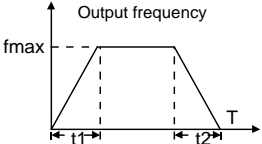
Function code	Name	Detailed instruction of parameters	Default value	Modify
		Setting range: 0.00–50.00Hz		
P01.02	Retention time of the starting frequency	<p>Set a proper starting frequency to increase the torque of the inverter during starting. During the retention time of the starting frequency, the output frequency of the inverter is the starting frequency. And then, the inverter will run from the starting frequency to the set frequency. If the set frequency is lower than the starting frequency, the inverter will stop running and keep in the stand-by state. The starting frequency is not limited in the lower limit frequency.</p>  <p>Setting range: 0.0–50.0s</p>	0.0s	⊙
P01.03	The braking current before starting	The inverter will carry out DC braking at the braking current set before starting and it will speed up after the DC braking time. If the DC braking time is set to 0, the DC braking is invalid.	0.0%	⊙
P01.04	The braking time before starting	The stronger the braking current, the bigger the braking power. The DC braking current before starting means the percentage of the rated current of the inverter. Setting range of P01.03: 0.0–100.0% Setting range of P01.04: 0.00–50.00s	0.00s	⊙
P01.05	ACC/DEC selection	<p>The changing mode of the frequency during start-up and running.</p> <p>0: Linear type</p> <p>The output frequency increases or decreases linearly.</p> 	0	⊙

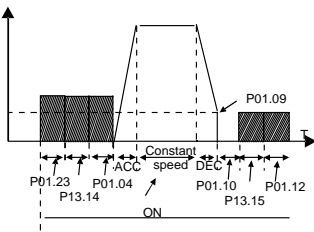
Function code	Name	Detailed instruction of parameters	Default value	Modify
		1: Reserved		
P01.06	Reserved			⊙
P01.07				⊙
P01.08	Stop mode	0: Decelerate to stop: after the stop command becomes valid, the inverter decelerates to decrease the output frequency during the set time. When the frequency decreases to P01.15, the inverter stops. 1: Coast to stop: after the stop command becomes valid, the inverter ceases the output immediately. And the load coasts to stop at the mechanical inertia.	0	○
P01.09	Starting frequency of DC braking	The starting frequency of stop braking: the inverter will carry on stop DC braking when the frequency is arrived during the procedure of decelerating to stop.	0.00Hz	○
P01.10	Waiting time of DC braking	The waiting time of stop braking: before the stop DC braking, the inverter will close output and begin to carry on the DC braking after the waiting time. This function is used to avoid the overcurrent fault caused by DC braking when the speed is too high.	0.00s	○
P01.11	DC braking current	Stop DC braking current: the DC brake added. The stronger the current, the bigger the DC braking effect.	0.0%	○
P01.12	DC braking time	The braking time of stop braking: the retention time of DC brake. If the time is 0, the DC brake is invalid. The inverter will stop at the set deceleration time. 	0.00s	○
		Setting range of P01.09: 0.00Hz–P00.03 Setting range of P01.10: 0.00–50.00s Setting range of P01.11: 0.0–100.0% Setting range of P01.12: 0.00–50.00s		
P01.13	Dead time of FWD/REV rotation	During the procedure of switching for/rev rotation, set the threshold by P01.14, which is as the table below:	0.0s	○

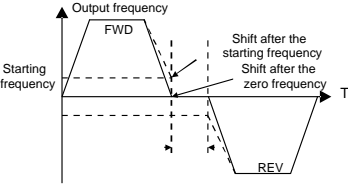
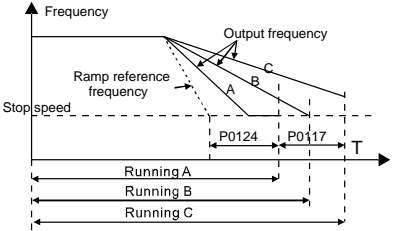
Function code	Name	Detailed instruction of parameters	Default value	Modify
		 <p>Setting range: 0.0–3600.0s</p>		
P01.14	Shifting between FWD/REV rotation	Set the threshold point of the inverter: 0: Switch after zero frequency 1: Switch after the starting frequency 2: Switch after the speed reach P01.15 and delay for P01.24	0	☉
P01.15	Stopping speed	0.00–100.00Hz	0.50Hz	☉
P01.16	Detection of stopping speed	0: Detect according to speed setting (no stopping delay) 1: Detect according to speed feedback (only valid for vector control)	1	☉
P01.17	Detection time of feedback speed	If set P01.16 to 1, the feedback frequency is less than or equal to P01.15 and detect in the set time of P01.17, the inverter will stop; otherwise the inverter will stop after the set time of P01.17.  <p>Setting range: 0.00–100.00s (only valid when P01.16=1)</p>	0.50s	☉
P01.18	Terminal running protection when powering on	When the running commands are controlled by the terminal, the system will detect the state of the running terminal during powering on. 0: The terminal running command is invalid when powering on. Even the running command is detected to be valid during powering on, the inverter won't run and the system keeps in the protection state until the	0	○

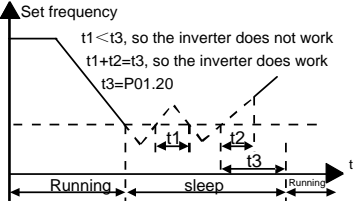
Function code	Name	Detailed instruction of parameters	Default value	Modify
		running command is canceled and enabled again. 1: The terminal running command is valid when powering on. If the running command is detected to be valid during powering on, the system will start the inverter automatically after the initialization. Note: this function should be selected with cautions, or serious result may follow.		
P01.19	Action if running frequency < lower limit frequency (valid >0)	This function code determines the running state of the inverter when the set frequency is lower than the lower-limit one. 0: Run at the lower-limit frequency 1: Stop 2: Hibernation The inverter will coast to stop when the set frequency is lower than the lower-limit one. If the set frequency is above the lower limit one again and it lasts for the time set by P01.20, the inverter will come back to the running state automatically.	0	☉
P01.20	Hibernation restore delay time	This function code determines the hibernation delay time. When the running frequency of the inverter is lower than the lower limit one, the inverter will pause to stand by. When the set frequency is above the lower limit one again and it lasts for the time set by P01.20, the inverter will run automatically. Note: The time is the total value when the set frequency is above the lower limit one. 	0.0s	○
P01.21	Restart after power off	This function can enable the inverter start or not after the power off and then power on. 0: Disable	0	○

Function code	Name	Detailed instruction of parameters	Default value	Modify
		1: Enable, if the starting need is met, the inverter will run automatically after waiting for the time defined by P01.22.		
P01.22	The waiting time of restart after power off	<p>The function determines the waiting time before the automatic running of the inverter when powering off and then powering on.</p> <p>Setting range: 0.0–3600.0s (valid when P01.21=1)</p>	1.0s	<input type="radio"/>
P01.23	Start delay time	<p>The function determines the brake release after the running command is given, and the inverter is in a stand-by state and wait for the delay time set by P01.23</p> <p>Setting range: 0.0–60.0s</p>	0.0s	<input type="radio"/>
P01.24	Delay time of the stop speed	Setting range: 0.0–100.0 s	0.0s	<input type="radio"/>
P01.25	0Hz output selection	<p>Select the output mode at 0Hz.</p> <p>0: Output without voltage 1: Output with voltage 2: Output at DC braking current at stopping</p>	0	<input type="radio"/>
P02 Group Motor 1				
P02.00	Motor type 1	<p>0: Asynchronous motor 1: Synchronous motor</p> <p>Note: Switch the current motor by the switching channel of P08.31.</p>	0	<input checked="" type="radio"/>
P02.01	Rated power of AM 1	0.75–110kW (1–150HP)	Depend on model	<input checked="" type="radio"/>
P02.02	Rated frequency of AM 1	0.01Hz–P00.03 (the max frequency)	60.00Hz	<input checked="" type="radio"/>
P02.03	Rated speed of AM 1	1–36000rpm	Depend on model	<input checked="" type="radio"/>
P02.04	Rated voltage of AM 1	0–1200V		<input checked="" type="radio"/>

Function code	Name	Detailed instruction of parameters	Default value	Modify
P02.05	Rated current of AM 1	0.8–6000.0A		☉
P02.06	Stator resistor of AM 1	0.001–65.535Ω		○
P02.07	Rotor resistor of AM 1	0.001–65.535Ω		○
P02.08	Leakage inductance of AM 1	0.1–6553.5mH		○
P02.09	Mutual inductance of AM 1	0.1–6553.5mH		○
P02.10	Non-load current of AM 1	0.1–6553.5A		○
P02.11	Magnetic saturation coefficient 1 for the iron core of AM 1	0.0–100.0%	80.0%	☉
P02.12	Magnetic saturation coefficient 2 for the iron core of AM 1	0.0–100.0%	68.0%	☉
P02.13	Magnetic saturation coefficient 3 for the iron core of AM 1	0.0–100.0%	57.0%	☉
P02.14	Magnetic saturation coefficient 4 for the iron core of AM1	0.0–100.0%	40.0%	☉
P02.15	Rated power of SM 1	0.75–110kW (1–150HP)	Depend on model	☉
P02.16	Rated frequency of	0.01Hz–P00.03 (the max frequency)	60.00Hz	☉

Function code	Name	Detailed instruction of parameters	Default value	Modify
	SM 1			
P02.17	Number of poles pairs of SM 1	1–50	2	☉
P02.18	Rated voltage of SM 1	0–1200V	Depend on model	☉
P02.19	Rated current of SM 1	0.8–6000.0A		☉
P02.20	Stator resistor of SM 1	0.001–65.535Ω		○
P02.21	Direct axis inductance of SM 1	0.01–655.35mH		○
P02.22	Quadrature axis inductance of SM 1	0.01–655.35mH		○
P02.23	Back EMF constant of SM 1	<p>When P00.15=2, the set value of P02.23 cannot be updated by autotuning, count according to the following method.</p> <p>The counter-electromotive force constant can be counted according to the parameters on the name plate of the motor. There are three ways to count:</p> <p>1. If the name plate designate the counter-electromotive force constant K_e, then: $E=(K_e * n_N * 2 \pi) / 60$</p> <p>2. If the name plate designate the counter-electromotive force constant $E'(V/1000r/min)$, then: $E=E' * n_N / 1000$</p> <p>3. If the name plate does not designate the above parameters, then: $E=P / \sqrt{3} * I$</p> <p>In the above formulas: n_N is the rated rotation speed, P is the rated power and I is the rated current. Setting range: 0–10000</p>		300
P02.24	Initial pole position of SM	0x0000–0xFFFF	0	●

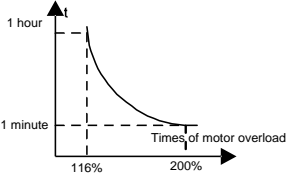
Function code	Name	Detailed instruction of parameters	Default value	Modify
	1 (reserved)			
P02.25	Identification current of SM 1 (reserved)	0%–50% (rated current of the motor)	10%	●
P02.26	Motor 1 overload protection	<p>0: No protection</p> <p>1: Common motor (with low speed compensation). Because the heat-releasing effect of the common motors will be weakened, the corresponding electric heat protection will be adjusted properly. The low speed compensation characteristic mentioned here means reducing the threshold of the overload protection of the motor whose running frequency is below 30Hz.</p> <p>2: Variable frequency motor (without low speed compensation) Because the heat-releasing effect of the specific motors won't be impacted by the rotation speed, it is not necessary to adjust the protection value during low-speed running.</p>	2	◎
P02.27	Motor 1 overload protection coefficient	<p>Times of motor overload $M = I_{out}/(I_n * K)$</p> <p>I_n is the rated current of the motor, I_{out} is the output current of the inverter and K is the motor protection coefficient.</p> <p>So, the bigger the value of K is, the smaller the value of M is. When $M = 116\%$, the fault will be reported after 1 hour, when $M = 200\%$, the fault will be reported after 1 minute, when $M \geq 400\%$, the fault will be reported instantly.</p>  <p>Setting range: 20.0%–120.0%</p>	100.0%	○
P02.28	Correction coefficient of motor 1 power	<p>Correct the power displaying of motor 1.</p> <p>Only impact the displaying value other than the control performance of the inverter.</p> <p>Setting range: 0.00–3.00</p>	1.00	●

Function code	Name	Detailed instruction of parameters	Default value	Modify
P02.29	Parameter display of motor 1	0: Display according to the motor type 1: Display all	0	●
P03 Group Vector control				
P03.00	Speed loop proportional gain1	<p>The parameters P03.00–P03.05 only apply to vector control mode. Below the switching frequency 1(P03.02), the speed loop PI parameters are: P03.00 and P03.01. Above the switching frequency 2(P03.05), the speed loop PI parameters are: P03.03 and P03.04. PI parameters are gained according to the linear change of two groups of parameters. It is shown as below:</p>	20.0	○
P03.01	Speed loop integral time1		0.200s	○
P03.02	Low switching frequency		5.00Hz	○
P03.03	Speed loop proportional gain 2		20.0	○
P03.04	Speed loop integral time 2		0.200s	○
P03.05	High switching frequency		<p>Setting the proportional coefficient and integral time of the adjustor can change the dynamic response performance of vector control speed loop. Increasing the proportional gain and decreasing the integral time can speed up the dynamic response of the speed loop. But too high proportional gain and too low integral time may cause system vibration and overshoot. Too low proportional gain may cause system vibration and speed static deviation. PI has a close relationship with the inertia of the system. Adjust on the base of PI according to different loads to meet various demands.</p> <p>Setting range of P03.00: 0–200.0 Setting range of P03.01: 0.000–10.000s Setting range of P03.02: 0.00Hz–P03.05 Setting range of P03.03: 0–200.0 Setting range of P03.04: 0.000–10.000s Setting range of P03.05: P03.02–P00.03 (max output frequency)</p>	10.00Hz
P03.06	Speed loop output filter	0–8 (corresponds to $0-2^8/10\text{ms}$)	0	○

Function code	Name	Detailed instruction of parameters	Default value	Modify
P03.07	Compensation coefficient of electromotion slip	Slip compensation coefficient is used to adjust the slip frequency of the vector control and improve the speed control accuracy of the system. Adjusting the parameter properly can control the speed steady-state error. Setting range: 50%–200%	100%	<input type="radio"/>
P03.08	Compensation coefficient of braking slip			<input type="radio"/>
P03.09	Current loop percentage coefficient P	Note: 1. These two parameters adjust the PI adjustment parameter of the current loop which affects the dynamic response speed and control accuracy directly. Generally, users do not need to change the default value. 2. Only apply to the vector control mode without PG 0 (P00.00=0). Setting range: 0–65535	1000	<input type="radio"/>
P03.10	Current loop integral coefficient 1			<input type="radio"/>
P03.11	Torque setting method	This parameter is used to enable the torque control mode, and set the torque. 0: Torque control is invalid 1: Keypad setting torque (P03.12) 2: Analog AI1 setting torque 3: Analog AI2 setting torque 4: Analog AI3 setting torque 5: Pulse frequency HDI setting torque 6: Multi-step torque setting 7: MODBUS communication setting torque 8: PROFIBUS\CANopen communication setting torque 9: Ethernet communication setting torque 10: Reserved Note: Setting modes 2–10, 100% corresponds to three times of the rated current of the motor.	0	<input type="radio"/>
P03.12	Keypad setting torque	Setting range: -300.0%–300.0% (rated motor current)	50.0%	<input type="radio"/>
P03.13	Torque reference filter time	0.000–10.000s	0.010s	<input type="radio"/>
P03.14	Upper frequency of	0: Keypad (P03.16 sets P03.14, P03.17 sets P03.15) 1: AI1	0	<input type="radio"/>

Function code	Name	Detailed instruction of parameters	Default value	Modify
	forward rotation in vector control	2: AI2 3: AI3 4: Pulse frequency HDI setting upper-limit frequency		
P03.15	Upper frequency of reverse rotation in vector control	5: Multi-step setting upper-limit frequency 6: MODBUS communication setting upper-limit frequency 7: PROFIBUS\CANopen communication setting upper-limit frequency 8: Ethernet communication setting upper-limit frequency 9: Reserved Note: Setting method 1–9, 100% corresponds to the maximum frequency.	0	○
P03.16	Keypad setting for upper frequency of forward rotation	This function is used to set the upper limit of the frequency. P03.16 sets the value of P03.14; P03.17 sets the value of P03.15.	60.00Hz	○
P03.17	Keypad setting for upper frequency of reverse rotation	Setting range: 0.00 Hz–P00.03 (max output frequency)	60.00Hz	○
P03.18	Upper electromotion torque source	This function code is used to select the electromotion and braking torque upper-limit setting source selection. 0: Keypad setting upper-limit frequency (P03.20 sets	0	○
P03.19	Upper braking torque source	P03.18, P03.21 sets P03.19) 1: AI1 2: AI2 3: AI3 4: HDI 5: MODBUS communication 6: PROFIBUS\CANopen communication 7: Ethernet communication 8: Reserved Note: setting mode 1–9, 100% corresponds to three times of the motor current.	0	○
P03.20	Keypad setting	The function code is used to set the limit of the	180.0%	○

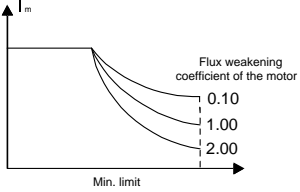
Function code	Name	Detailed instruction of parameters	Default value	Modify
	of electromotion torque	torque. Setting range: 0.0–300.0% (motor rated current)		
P03.21	Keypad setting of braking torque		180.0%	<input type="radio"/>
P03.22	Flux weakening coefficient in constant power zone	The usage of motor in weakening control. 	0.3	<input type="radio"/>
P03.23	Lowest flux weakening point in constant power zone	Function code P03.22 and P03.23 are effective at constant power. The motor will enter into the weakening state when the motor runs at rated speed. Change the weakening curve by modifying the weakening control coefficient. The bigger the weakening control coefficient is, the steeper the weak curve is. Setting range of P03.22: 0.1–2.0 Setting range of P03.23: 10%–100%	20%	<input type="radio"/>
P03.24	Max voltage limit	P03.24 set the max Voltage of the inverter, which is dependent on the site situation. The setting range: 0.0–120.0%	100.0%	<input checked="" type="radio"/>
P03.25	Pre-exciting time	Pre-activate the motor when the inverter starts up. Build up a magnetic field inside the inverter to improve the torque performance during the starting process. The setting time: 0.000–10.000s	0.300s	<input type="radio"/>
P03.26	Flux weakening proportional gain	0–8000 Note: P03.24–P03.26 are invalid for vector mode.	1000	<input type="radio"/>
P03.27	Vector control speed	0: Display the actual value 1: Display the setting value	0	<input type="radio"/>
P03.28	Compensation coefficient of	0.0–100.0% Adjust P03.28 to compensate the coefficient of static	0.0%	

Function code	Name	Detailed instruction of parameters	Default value	Modify
	static friction	friction. Only valid when setting in 1Hz.		
P03.29	Compensation coefficient of dynamic friction	0.0–100.0% Adjust P03.29 to compensate the coefficient of static friction. Only valid when setting in 1Hz.	0.0%	
P04 Group SVPWM control				
P04.00	Motor 1V/F curve setting	<p>These function codes define the V/F curve of UMI-B5 UL motor 1 to meet different loads needs.</p> <p>0: Straight line V/F curve; applying to the constant torque load</p> <p>1: Multi-dots V/F curve</p> <p>2: Torque step-down V/F curve (1.3 order)</p> <p>3: Torque step-down V/F curve (1.7 order)</p> <p>4: Torque step-down V/F curve (2.0 order)</p> <p>Curves 2–4 apply to the torque loads such as fans and water pumps. Users can adjust according to the features of the loads to achieve a best energy-consuming effect.</p> <p>5: Customized V/F (V/F separation); in this mode, V and F can be separated from adjusted through the frequency given channel set by P00.06 or voltage given channel set by P04.27 to change the curve feature.</p> <p>Note: V_b in the below picture is the motor rated voltage and f_b is the motor rated frequency.</p>	0	⊙
P04.01	Torque boost of motor 1	Torque boost to the output voltage for the features of low frequency torque. P04.01 is for the max Output voltage V_b .	0.0%	○
P04.02	Torque boost close of motor 1	P04.02 defines the percentage of closing frequency of manual torque to f_b . Torque boost should be selected according to the load. The bigger the load is, the bigger the boost is. Too big torque boost is inappropriate because the motor will run with over-magnetic, and the current of	20.0%	○

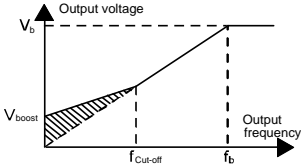
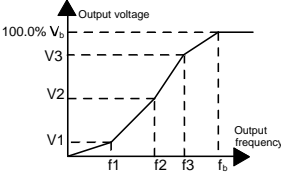
Function code	Name	Detailed instruction of parameters	Default value	Modify
		<p>the inverter will increase to raise the temperature of the inverter and decrease the efficiency.</p> <p>When the torque boost is set to 0.0%, the inverter is automatic torque boost.</p> <p>Torque boost threshold: under the threshold, the torque boost is valid, but over the threshold, the torque boost is invalid.</p>  <p>Setting range of P04.01: 0.0%: (automatic) 0.1%–10.0% Setting range of P04.02: 0.0%–50.0%</p>		
P04.03	V/F frequency 1 of motor 1	 <p>When P04.00 = 1, the user can set V//F curve through P04.03–P04.08.</p> <p>V/F is generally set according to the load of the motor.</p> <p>Note: $V1 < V2 < V3$, $f1 < f2 < f3$. Too high low frequency voltage will heat the motor excessively or cause damage. The inverter may stall when overcurrent or overcurrent protection.</p> <p>Setting range of P04.03: 0.00Hz–P04.05 Setting range of P04.04: 0.0%–110.0% Setting range of P04.05: P04.03– P04.07 Setting range of P04.06: 0.0%–110.0% (the rated voltage of motor 1) Setting range of P04.07: P04.05– P02.02 (the rated frequency of motor 1) or P04.05– P02.16 (the rated frequency of motor 1) Setting range of P04.08: 0.0%–110.0% (the rated</p>	0.00Hz	<input type="radio"/>
P04.04	V/F voltage 1 of motor 1		00.0%	<input type="radio"/>
P04.05	V/F frequency 2 of motor 1		00.00Hz	<input type="radio"/>
P04.06	V/F voltage 2 of motor 1		00.0%	<input type="radio"/>
P04.07	V/F frequency 3 of motor 1		00.00Hz	<input type="radio"/>
P04.08	V/F voltage 3 of motor 1		0.00%	<input type="radio"/>

Function code	Name	Detailed instruction of parameters	Default value	Modify
		voltage of motor 1)		
P04.09	V/F slip compensation gain of motor 1	<p>This function code is used to compensate the change of the rotation speed caused by load during compensation SVPWM control to improve the rigidity of the motor. It can be set to the rated slip frequency of the motor which is counted as below:</p> $\Delta f = f_b - n * p / 60$ <p>Of which, f_b is the rated frequency of the motor, its function code is P02.02; n is the rated rotating speed of the motor and its function code is P02.03; p is the pole pair of the motor. 100.0% corresponds to the rated slip frequency Δf.</p> <p>Setting range: 0.0–200.0%</p>	100.0%	<input type="radio"/>
P04.10	Vibration control factor at low frequency of motor 1	<p>In SVPWM control mode, current fluctuation may occur to the motor at some frequency, especially the motor with big power. The motor cannot run stably or overcurrent may occur. These phenomena can be canceled by adjusting this parameter.</p> <p>Setting range of P04.10: 0–100 Setting range of P04.11: 0–100 Setting range of P04.12: 0.00Hz–P00.03 (the max frequency)</p>	10	<input type="radio"/>
P04.11	Vibration control factor at high frequency of motor 1		10	<input type="radio"/>
P04.12	Vibration control threshold of motor 1		30.00Hz	<input type="radio"/>
P04.13	Motor 2 V/F curve setting	<p>This group of parameters defines the V/F setting means of UMI-B5 UL motor 2 to meet various requirements of different loads. See P04.00–P04.12 for the detailed function code instruction.</p> <p>Note: P04 group includes two sets of V/F parameters of the motor which cannot display simultaneously. Only the selected V/F parameter can be shown. The motor selection can be defined by terminals function “the shift between motor 1 and motor 2”</p>	0	<input checked="" type="radio"/>
P04.14	Torque boost of motor 2		0.0%	<input type="radio"/>
P04.15	Torque boost close of motor 2		20.0%	<input type="radio"/>
P04.16	V/F frequency 1 of motor 2		0.00Hz	<input type="radio"/>
P04.17	V/F voltage 1 of motor 2		00.0%	<input type="radio"/>

Function code	Name	Detailed instruction of parameters	Default value	Modify
P04.18	V/F frequency 2 of motor 2		00.00Hz	<input type="radio"/>
P04.19	V/F voltage 2 of motor 2		00.0%	<input type="radio"/>
P04.20	V/F frequency 3 of motor 2		00.00Hz	<input type="radio"/>
P04.21	V/F voltage 3 of motor 2		00.0%	<input type="radio"/>
P04.22	V/F slip compensation gain of motor 2		100.0%	<input type="radio"/>
P04.23	Vibration control factor at low frequency of motor 2	In SVPWM control mode, current fluctuation may occur to the motor on some frequency, especially the motor with big power. The motor cannot run stably or overcurrent may occur. These phenomena can be canceled by adjusting this parameter. Setting range of P04.23: 0–100 Setting range of P04.24: 0–100 Setting range of P04.25: 0.00Hz–P00.03 (max frequency)	10	<input type="radio"/>
P04.24	Vibration control factor at high frequency of motor 2		10	<input type="radio"/>
P04.25	Vibration control threshold of motor 2		30.00Hz	<input type="radio"/>
P04.26	Energy-saving operation	0: No operation 1: Automatic energy-saving operation Motors will automatically adjust the output voltage to save energy when light loads.	0	<input checked="" type="radio"/>
P04.27	Voltage setting	Select the output setting channel at V/F curve separation. 0: Keypad: the output voltage is determined by P04.28. 1: AI1; 2: AI2; 3: AI3; 4: HDI; 5: Multi-step speed; 6: PID;	0	<input type="radio"/>

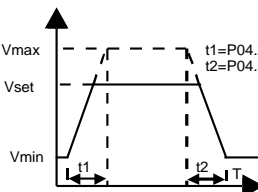
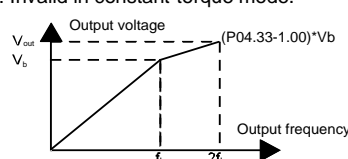
Function code	Name	Detailed instruction of parameters	Default value	Modify
		7: MODBUS communication; 8: PROFIBUS/CANopen communication; 9: Ethernet communication; 10: Reserved Note: 100% corresponds to the rated voltage of the motor.		
P04.28	Keypad setting voltage	The function code is the voltage displaying when the voltage is set through keypad. The setting range: 0.0%–100.0%	100.0%	<input type="radio"/>
P04.29	Voltage increasing time	Voltage increasing time is the time when the inverter accelerates from the output minimum voltage to the output maximum voltage.	5.0s	<input type="radio"/>
P04.30	Voltage decreasing time	Voltage decreasing time is the time when the inverter decelerates from the output maximum voltage to the output minimum voltage. The setting range: 0.0–3600.0s	5.0s	<input type="radio"/>
P04.31	Maximum output voltage	Set the upper and low limit of the output voltage. Setting range of P04.31: P04.32–100.0% (the rated voltage of the motor)	100.0%	<input checked="" type="radio"/>
P04.32	Minimum output voltage	Setting range of P04.32: 0.0%– P04.31 (the rated voltage of the motor) 	0.0%	<input checked="" type="radio"/>
P04.33	Flux weakening coefficient at constant power	Used to adjust the output voltage of inverter in SVPWM mode during flux weakening. Note: Invalid in constant-torque mode. 	1.00	<input type="radio"/>

Function code	Name	Detailed instruction of parameters	Default value	Modify
P05 Group Input terminals				
P05.00	HDI input selection	0: High pulse input. See P05.49–P05.54 1: Digital input. See P05.09	0	☉
P05.01	S1 terminals function selection	0: No function 1: Forward rotation operation 2: Reverse rotation operation	1	☉
P05.02	S2 terminals function selection	3: 3-wire control operation 4: Forward jogging 5: Reverse jogging	4	☉
P05.03	S3 terminals function selection	6: Coast to stop 7: Fault reset 8: Operation pause	7	☉
P05.04	S4 terminals function selection	9: External fault input 10: Increasing frequency setting (UP) 11: Decreasing frequency setting (DOWN)	0	☉
P05.05	S5 terminals function selection	12: Frequency setting clear 13: Shift between A setting and B setting 14: Shift between combination setting and A setting	0	☉
P05.06	S6 terminals function selection	15: Shift between combination setting and B setting 16: Multi-step speed terminal 1 17: Multi-step speed terminal 2	0	☉
P05.07	S7 terminals function selection	18: Multi-step speed terminal 3 19: Multi- step speed terminal 4 20: Multi- step speed pause	0	☉
P05.08	S8 terminals function selection	21: ACC/DEC time 1 22: ACC/DEC time 2 23: Simple PLC stop reset	0	☉
P05.09	HDI terminal function selection	24: Simple PLC pause 25: PID control pause 26: Traverse pause (stop at the current frequency) 27: Traverse reset (return to the center frequency) 28: Counter reset 29: Torque control disabling 30: ACC/DEC disabling 31: Counter triggering 32: Length reset 33: Cancel the frequency change setting temporarily 34: DC brake 35: Shift the motor 1 into motor 2	0	☉

Function code	Name	Detailed instruction of parameters	Default value	Modify																				
		36: Shift the command to the keypad 37: Shift the command to the terminals 38: Shift the command to the communication 39: Pre-magnetized command 40: Consumption power clear 41: Consumption power holding 42–60: Reserved 61: PID pole switching 62–63: Reserved																						
P05.10	Polarity selection of the input terminals	The function code is used to set the polarity of the input terminals. Set the bit to 0, the input terminal is anode. Set the bit to 1, the input terminal is cathode. <table border="1" style="margin: 10px auto;"> <tr> <td>BIT0</td> <td>BIT1</td> <td>BIT2</td> <td>BIT3</td> <td>BIT4</td> </tr> <tr> <td>S1</td> <td>S2</td> <td>S3</td> <td>S4</td> <td>S5</td> </tr> <tr> <td>BIT5</td> <td>BIT6</td> <td>BIT7</td> <td>BIT8</td> <td></td> </tr> <tr> <td>S6</td> <td>S7</td> <td>S8</td> <td>HDI</td> <td></td> </tr> </table> The setting range: 0x000–0x1FF	BIT0	BIT1	BIT2	BIT3	BIT4	S1	S2	S3	S4	S5	BIT5	BIT6	BIT7	BIT8		S6	S7	S8	HDI		0x000	○
BIT0	BIT1	BIT2	BIT3	BIT4																				
S1	S2	S3	S4	S5																				
BIT5	BIT6	BIT7	BIT8																					
S6	S7	S8	HDI																					
P05.11	ON-OFF filter time	Set the sample filter time of S1–S8 and HDI terminals. If the interference is strong, increase the parameter to avoid the disoperation. 0.000–1.000s	0.010s	○																				
P05.12	Virtual terminals setting	0x000–0x1FF (0: Disabled, 1: Enabled) BIT0: S1 virtual terminal BIT1: S2 virtual terminal BIT2: S3 virtual terminal BIT3: S4 virtual terminal BIT4: S5 virtual terminal BIT5: S6 virtual terminal BIT6: S7 virtual terminal BIT7: S8 virtual terminal BIT8: HDI virtual terminal	0x000	◎																				
P05.13	Terminals control running mode	Set the operation mode of the terminals control 0: 2-wire control 1, comply the enable with the direction. This mode is widely used. It determines the rotation direction by the defined FWD and REV terminals command.	0	◎																				

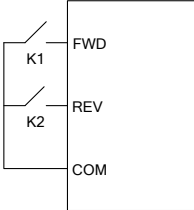
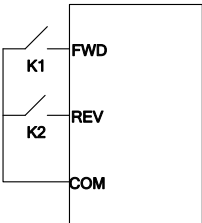
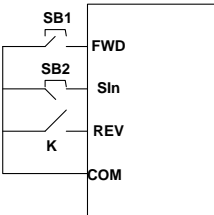
Function code	Name	Detailed instruction of parameters	Default value	Modify																																																			
		<div style="display: flex; align-items: center;">  <table border="1" style="margin-left: 20px;"> <tr><td>FWD</td><td>REV</td><td>Running command</td></tr> <tr><td>OFF</td><td>OFF</td><td>Stop</td></tr> <tr><td>ON</td><td>OFF</td><td>FWD running</td></tr> <tr><td>OFF</td><td>ON</td><td>REV running</td></tr> <tr><td>ON</td><td>ON</td><td>Hold</td></tr> </table> </div> <p>1: 2-wire control 2; Separate the enable from the direction. FWD defined by this mode is the enabling ones. The direction depends on the state of the defined REV.</p> <div style="display: flex; align-items: center;">  <table border="1" style="margin-left: 20px;"> <tr><td>FWD</td><td>REV</td><td>Running command</td></tr> <tr><td>OFF</td><td>OFF</td><td>Stopping</td></tr> <tr><td>ON</td><td>OFF</td><td>Forward running</td></tr> <tr><td>OFF</td><td>ON</td><td>Stopping</td></tr> <tr><td>ON</td><td>ON</td><td>Reverse running</td></tr> </table> </div> <p>2: 3-wire control 1; Sin is the enabling terminal on this mode, and the running command is caused by FWD and the direction is controlled by REV. Sin is natural closed.</p> <div style="display: flex; align-items: center;">  </div> <p>The direction control is as below during operation:</p> <table border="1" style="width: 100%; text-align: center;"> <thead> <tr> <th>SIn</th> <th>REV</th> <th>Previous direction</th> <th>Current direction</th> </tr> </thead> <tbody> <tr> <td rowspan="2">ON</td> <td rowspan="2">OFF→ON</td> <td>Forward</td> <td>Reverse</td> </tr> <tr> <td>Reverse</td> <td>Forward</td> </tr> <tr> <td rowspan="2">ON</td> <td rowspan="2">ON→OFF</td> <td>Reverse</td> <td>Forward</td> </tr> <tr> <td>Forward</td> <td>Reverse</td> </tr> <tr> <td rowspan="2">ON→OFF</td> <td>ON</td> <td colspan="2" rowspan="2">Decelerate to stop</td> </tr> <tr> <td>OFF</td> </tr> </tbody> </table>	FWD	REV	Running command	OFF	OFF	Stop	ON	OFF	FWD running	OFF	ON	REV running	ON	ON	Hold	FWD	REV	Running command	OFF	OFF	Stopping	ON	OFF	Forward running	OFF	ON	Stopping	ON	ON	Reverse running	SIn	REV	Previous direction	Current direction	ON	OFF→ON	Forward	Reverse	Reverse	Forward	ON	ON→OFF	Reverse	Forward	Forward	Reverse	ON→OFF	ON	Decelerate to stop		OFF		
FWD	REV	Running command																																																					
OFF	OFF	Stop																																																					
ON	OFF	FWD running																																																					
OFF	ON	REV running																																																					
ON	ON	Hold																																																					
FWD	REV	Running command																																																					
OFF	OFF	Stopping																																																					
ON	OFF	Forward running																																																					
OFF	ON	Stopping																																																					
ON	ON	Reverse running																																																					
SIn	REV	Previous direction	Current direction																																																				
ON	OFF→ON	Forward	Reverse																																																				
		Reverse	Forward																																																				
ON	ON→OFF	Reverse	Forward																																																				
		Forward	Reverse																																																				
ON→OFF	ON	Decelerate to stop																																																					
	OFF																																																						

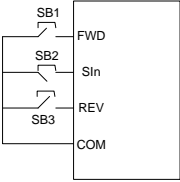
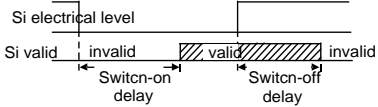
Function code	Name	Detailed instruction of parameters	Default value	Modify																					
		<p>3: 3-wire control 2; Sin is the enabling terminal on this mode, and the running command is caused by SB1 or SB3 and both of them control the running direction. NC SB2 generates the stop command.</p>  <table border="1" data-bbox="374 518 807 754"> <thead> <tr> <th>Sin</th> <th>FWD</th> <th>REV</th> <th>Direction</th> </tr> </thead> <tbody> <tr> <td rowspan="2">ON</td> <td rowspan="2">OFF→ON</td> <td>ON</td> <td>Forward</td> </tr> <tr> <td>OFF</td> <td>Reverse</td> </tr> <tr> <td rowspan="2">ON</td> <td>ON</td> <td>OFF→</td> <td>Forward</td> </tr> <tr> <td>OFF</td> <td>ON</td> <td>Reverse</td> </tr> <tr> <td>ON→OFF</td> <td></td> <td></td> <td>Decelerate to stop</td> </tr> </tbody> </table> <p>Note: for the 2-wire running mode, when FWD/REV terminal is valid, the inverter stop because of the stopping command from other sources, even the control terminal FWD/REV keeps valid; the inverter won't work when the stopping command is canceled. Only when FWD/REV is re-launched, the inverter can start again. For example, the valid STOP/RST stop when PLC signal cycles stop, fixed-length stop and terminal control (see P07.04).</p>	Sin	FWD	REV	Direction	ON	OFF→ON	ON	Forward	OFF	Reverse	ON	ON	OFF→	Forward	OFF	ON	Reverse	ON→OFF			Decelerate to stop		
Sin	FWD	REV	Direction																						
ON	OFF→ON	ON	Forward																						
		OFF	Reverse																						
ON	ON	OFF→	Forward																						
	OFF	ON	Reverse																						
ON→OFF			Decelerate to stop																						
P05.14	Switch-on delay of S1 terminal	<p>The function code defines the corresponding delay time of electrical level of the programmable terminals from switching on to switching off.</p> 	0.000s	○																					
P05.15	Switch-off delay of S1 terminal		0.000s	○																					
P05.16	Switch-on delay of S2 terminal		0.000s	○																					
P05.17	Switch-off delay of S2 terminal		Setting range: 0.000~50.000s	0.000s	○																				

Function code	Name	Detailed instruction of parameters	Default value	Modify
P05.18	Switch-on delay of S3 terminal		0.000s	<input type="radio"/>
P05.19	Switch-off delay of S3 terminal		0.000s	<input type="radio"/>
P05.20	Switch-on delay of S4 terminal		0.000s	<input type="radio"/>
P05.21	Switch-off delay of S4 terminal		0.000s	<input type="radio"/>
P05.22	Switch-on delay of S5 terminal		0.000s	<input type="radio"/>
P05.23	Switch-off delay of S5 terminal		0.000s	<input type="radio"/>
P05.24	Switch-on delay of S6 terminal		0.000s	<input type="radio"/>
P05.25	Switch-off delay of S6 terminal		0.000s	<input type="radio"/>
P05.26	Switch-on delay of S7 terminal		0.000s	<input type="radio"/>
P05.27	Switch-off delay of S7 terminal		0.000s	<input type="radio"/>
P05.28	Switch-on delay of S8 terminal		0.000s	<input type="radio"/>
P05.29	Switch-off delay of S8 terminal		0.000s	<input type="radio"/>
P05.30	Switch-on delay of HDI		0.000s	<input type="radio"/>

Function code	Name	Detailed instruction of parameters	Default value	Modify
	terminal			
P05.31	Switch-off delay of HDI terminal		0.000s	<input type="radio"/>
P05.32	Lower limit of AI1	<p>The function code defines the relationship between the analog input voltage and its corresponding set value. If the analog input voltage beyond the set minimum or maximum input value, the inverter will count at the minimum or maximum one.</p> <p>When the analog input is the current input, the corresponding voltage of 0–20mA is 0–10V.</p> <p>In different cases, the corresponding rated value of 100.0% is different. See the application for detailed information.</p> <p>The figure below illustrates different applications:</p>	0.00V	<input type="radio"/>
P05.33	Corresponding setting of the lower limit of AI1		0.0%	<input type="radio"/>
P05.34	Upper limit of AI1		10.00V	<input type="radio"/>
P05.35	Corresponding setting of the upper limit of AI1		100.0%	<input type="radio"/>
P05.36	AI1 input filter time		0.100s	<input type="radio"/>
P05.37	Lower limit of AI2		0.00V	<input type="radio"/>
P05.38	Corresponding setting of the lower limit of AI2		0.0%	<input type="radio"/>
P05.39	Upper limit of AI2		10.00V	<input type="radio"/>
P05.40	Corresponding setting of the upper limit of AI2		100.0%	<input type="radio"/>
P05.41	AI2 input filter time		0.100s	<input type="radio"/>
P05.42	Lower limit of AI3	-10.00V	<input type="radio"/>	
P05.43	Corresponding setting of the lower limit of AI3	-100.0%	<input type="radio"/>	

Function code	Name	Detailed instruction of parameters	Default value	Modify
P05.44	Middle value of AI3	Setting range of P05.37: 0.00V–P05.39 Setting range of P05.38: -100.0%–100.0%	0.00V	<input type="radio"/>
P05.45	Corresponding middle setting of AI3	Setting range of P05.39: P05.37–10.00V Setting range of P05.40: -100.0%–100.0% Setting range of P05.41: 0.000s–10.000s	0.0%	<input type="radio"/>
P05.46	Upper limit of AI3	Setting range of P05.42: -10.00V–P05.44 Setting range of P05.43: -100.0%–100.0%	10.00V	<input type="radio"/>
P05.47	Corresponding setting of the upper limit of AI3	Setting range of P05.44: P05.42–P05.46 Setting range of P05.45: -100.0%–100.0% Setting range of P05.46: P05.44–10.00V Setting range of P05.47: -100.0%–100.0%	100.0%	<input type="radio"/>
P05.48	AI3 input filter time	Setting range of P05.48: 0.000s–10.000s	0.100s	<input type="radio"/>
P05.49	HDI high-speed pulse input function selection	The function selection when HDI terminals is high-speed pulse input 0: Frequency setting input, frequency setting source 1: Counter input, high-speed pulse counter input terminals 2: Length counting input, length counter input terminals	0	<input checked="" type="radio"/>
P05.50	Lower limit frequency of HDI	0.000kHz–P05.52	0.000kHz	<input type="radio"/>
P05.51	Corresponding setting of HDI low frequency setting	-100.0%–100.0%	0.0%	<input type="radio"/>
P05.52	Upper limit frequency of HDI	P05.50–50.000kHz	50.000kHz	<input type="radio"/>
P05.53	Corresponding setting of upper limit frequency of HDI	-100.0%–100.0%	100.0%	<input type="radio"/>
P05.54	HDI frequency input filter time	0.000s–10.000s	0.100s	<input type="radio"/>

Function code	Name	Detailed instruction of parameters	Default value	Modify
P06 Group Output terminals				
P06.00	HDO output	The function selection of the high-speed pulse output terminals. 0: Open collector pole high speed pulse output: The max pulse frequency is 50.0kHz. See P06.27–P06.31 for detailed information of the related functions. 1: Open collector pole output. See P06.02 for detailed information of the related functions.	0	☉
P06.01	Y1 output	0: Invalid	0	○
P06.02	HDO output	1: In operation	0	○
P06.03	Relay RO1 output	2: Forward rotation operation 3: Reverse rotation operation	1	○
P06.04	Relay RO2 output	4: Jogging operation 5: The inverter fault 6: Frequency degree test FDT1 7: Frequency degree test FDT2 8: Frequency arrival 9: Zero speed running 10: Upper limit frequency arrival 11: Lower limit frequency arrival 12: Ready for operation 13: Pre-magnetizing 14: Overload pre-alarm 15: Underload pre-alarm 16: Completion of simple PLC stage 17: Completion of simple PLC cycle 18: Setting count value arrival 19: Defined count value arrival 20: External fault valid 21: Length arrival 22: Running time arrival 23: MODBUS communication virtual terminals output 24: PROFIBUS/CANopen communication virtual terminals output 25: Ethernet communication virtual terminals output 26: Voltage establishment finished 27–30: Reserved	5	○
P06.05	Polarity of	The function code is used to set the pole of the	00	○

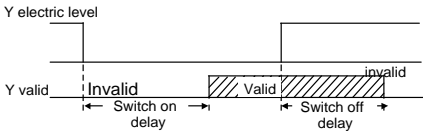
Function code	Name	Detailed instruction of parameters	Default value	Modify								
	output terminals	output terminal. When the current bit is set to 0, input terminal is positive. When the current bit is set to 1, input terminal is negative. <table border="1" style="margin-left: auto; margin-right: auto;"> <tr> <td>BIT0</td> <td>BIT1</td> <td>BIT2</td> <td>BIT3</td> </tr> <tr> <td>Y</td> <td>HDO</td> <td>RO1</td> <td>RO2</td> </tr> </table> Setting range: 00–0F	BIT0	BIT1	BIT2	BIT3	Y	HDO	RO1	RO2		
BIT0	BIT1	BIT2	BIT3									
Y	HDO	RO1	RO2									
P06.06	Y1 switch-on delay time	The function code defines the corresponding delay time of the electrical level change during the programmable terminal switching on and off.  <p>The setting range: 0.000–50.000s</p> <p>Note: P06.08 and P06.08 are valid only when P06.00=1.</p>	0.000s	○								
P06.07	Y1 switch-off delay time		0.000s	○								
P06.08	HDO switch-on delay time		0.000s	○								
P06.09	HDO switch-off delay time		0.000s	○								
P06.10	RO1 switch-on delay time		0.000s	○								
P06.11	RO1 switch-off delay time		0.000s	○								
P06.12	RO2 switch-on delay time		0.000s	○								
P06.13	RO2 switch-off delay time		0.000s	○								
P06.14	AO1 output		0: Running frequency	0	○							
P06.15	AO2 output		1: Set frequency	0	○							
P06.16	HDO high-speed pulse output		2: Ramp reference frequency 3: Running rotation speed 4: Output current (relative to 2 times of the rated current of the inverter) 5: Output current (relative to 2 times of the rated current of the motor) 6: Output voltage 7: Output power 8: Set torque value 9: Output torque	0	○							

Function code	Name	Detailed instruction of parameters	Default value	Modify
		10: AI1 input value 11: AI2 input value 12: AI3 input value 13: High speed pulse HDI input value 14: MODBUS communication set value 1 15: MODBUS communication set value 2 16: PROFIBUS/CANopen communication set value 1 17: PROFIBUS/CANopen communication set value 2 18: Ethernet communication set value 1 19: Ethernet communication set value 2 20–21: Reserved 22: Torque current (relative to 3 times of the rated current of the motor) 23: Ramp reference frequency (with sign) 24–30: Reserved		
P06.17	Lower output limit of AO1	The above function codes define the relative relationship between the output value and analog output. When the output value exceeds the range of set maximum or minimum output, it will count according to the low-limit or upper-limit output. When the analog output is current output, 1mA equals to 0.5V. In different cases, the corresponding analog output of 100% of the output value is different. For detailed information, refer to analog output instructions in Chapter 7.	0.0%	<input type="radio"/>
P06.18	Corresponding AO1 output of lower limit		0.00V	<input type="radio"/>
P06.19	Upper output limit of AO1		100.0%	<input type="radio"/>
P06.20	Corresponding AO1 output of upper limit		10.00V	<input type="radio"/>
P06.21	AO1 output filter time		0.000s	<input type="radio"/>
P06.22	Lower output limit of AO2		0.0%	<input type="radio"/>
P06.23	Corresponding AO2 output of lower limit		0.00V	<input type="radio"/>
P06.24	Upper output limit of AO2		100.0%	<input type="radio"/>
P06.25	Corresponding AO2 output of upper limit		10.00V	<input type="radio"/>
P06.26	AO2 output		0.000s	<input type="radio"/>

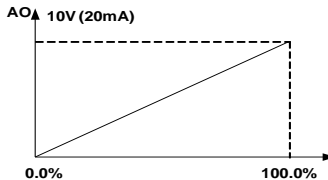

Function code	Name	Detailed instruction of parameters	Default value	Modify
P06.27	filter time	Setting range of P06.24: P06.22–100.0%		
	Lower output limit of HDO	Setting range of P06.25: 0.00V–10.00V Setting range of P06.26: 0.000s–10.000s	0.0%	○
P06.28	Corresponding HDO output of lower limit	Setting range of P06.27: -100.0%–P06.29 Setting range of P06.28: 0.00–50.00kHz Setting range of P06.29: P06.27–100.0%	0.00kHz	○
	Upper output limit of HDO	Setting range of P06.30: 0.00–50.00kHz Setting range of P06.31: 0.000s–10.000s	100.0%	○
P06.30	Corresponding HDO output of upper limit		50.00kHz	○
P06.31	HDO output filter time		0.000s	○
P07 Group Human-Machine Interface				
P07.00	User's password	0–65535 The password protection will be valid when setting any non-zero number. 00000: Clear the previous user's password, and make the password protection invalid. After the set user's password becomes valid, if the password is incorrect, users cannot enter the parameter menu. Only correct password can make the user check or modify the parameters. Remember all users' passwords. Retreat editing state of the function codes and the password protection will become valid in minute. If the valid password is available, press PRG/ESC to enter into the editing state of the function codes, and then "0.0.0.0.0" will be displayed. Unless input right password, the operator cannot enter into it. Note: restoring to the default value can clear the password, use it with caution.	0	○
P07.01	Parameter copy	The function code determines the manner of parameters copy. 0: No operation 1: Upload the local function parameter to the keypad 2: Download the keypad function parameter to local address (including the motor parameters)	0	◎

Function code	Name	Detailed instruction of parameters	Default value	Modify
		3: Download the keypad function parameter to local address (excluding the motor parameter of P02 and P12 group) 4: Download the keypad function parameters to local address (only for the motor parameter of P02 and P12 group) Note: After completing the 1–4 operations, the parameter will come back to 0 automatically; the function of upload and download excludes the factory parameters of P29.		
P07.02	QUICK/JOG function selection	0: No function 1: Jogging. Press QUICK/JOG to begin the jogging running. 2: Shift the display state by the shifting key. Press QUICK/JOG to shift the displayed function code from right to left. 3: Shift between forward rotations and reverse rotations. Press QUICK/JOG to shift the direction of the frequency commands. This function is only valid in the keypad commands channels. 4: Clear UP/DOWN settings. Press QUICK/JOG to clear the set value of UP/DOWN. 5: Coast to stop. Press QUICK/JOG to coast to stop. 6: Shift the given manner of running commands. Press QUICK/JOG to shift the given manner of running commands. 7: Quick commissioning mode (committee according to the non-factory parameter) Note: Press QUICK/JOG to shift between forward rotation and reverse rotation, the inverter does not remember the state after shifting during powering off. The inverter will run in the running direction set according to P00.13 during next powering on.	1	⊙
P07.03	Shifting sequence selection of QUICK/JOG commands	When P07.02=6, set the shifting sequence of running command channels. 0: Keypad control→terminals control →communication control 1: Keypad control←→terminals control 2: Keypad control←→communication control	0	○

Function code	Name	Detailed instruction of parameters	Default value	Modify
		3: Terminals control←→communication control		
P07.04	STOP/RST stop function	STOP/RST is valid for stop function. STOP/RST is valid in any state for the fault reset. 0: Only valid for the keypad control 1: Both valid for keypad and terminals control 2: Both valid for keypad and communication control 3: Valid for all control modes	0	○
P07.05	Parameters state 1	0x0000–0xFFFF BIT0: running frequency (Hz on) BIT1: set frequency (Hz flickering) BIT2: bus voltage (Hz on) BIT3: output voltage (V on) BIT4: output current (A on) BIT5: running rotation speed (rpm on) BIT6: output power (% on) BIT7: output torque (% on) BIT8: PID reference (% flickering) BIT9: PID feedback value (% on) BIT10: input terminals state BIT11: output terminals state BIT12: torque set value (% on) BIT13: pulse counter value BIT14: length value BIT15: PLC and the current stage in multi-step speed	0x03FF	○
P07.06	Parameters state 2	0x0000–0xFFFF BIT0: AI1 (V on) BIT1: AI2 (V on) BIT2: AI3 (V on) BIT3: HDI frequency BIT4: motor overload percentage (% on) BIT5: the inverter overload percentage (% on) BIT6: ramp frequency given value (Hz on) BIT7: linear speed BIT8: AC inlet current (A on) BIT9: upper limit frequency (Hz on) BIT9–15: reserved	0x0000	
P07.07	Parameters for stopping state	0x0000–0xFFFF BIT0: set frequency (Hz on, frequency flickering slowly)	0x00FF	○

Function code	Name	Detailed instruction of parameters	Default value	Modify
		BIT1: bus voltage (V on) BIT2: input terminals state BIT3: output terminals state BIT4: PID reference (% flickering) BIT5: PID feedback value (% on) BIT6: torque reference (% on) BIT7: AI1 (V on) BIT8: AI2 (V on) BIT9: AI3 (V on) BIT10: HDI frequency BIT11: PLC and the current stage in multi-step speed BIT12: pulse counters BIT13: length value BIT14: upper limit frequency (Hz on) BIT15: reserved		
P07.08	Frequency coefficient	0.01–10.00 Displayed frequency=running frequency* P07.08	1.00	<input type="radio"/>
P07.09	Rotation speed coefficient	0.1–999.9% Mechanical rotation speed =120*displayed running frequency×P07.09/motor pole pairs	100.0%	<input type="radio"/>
P07.10	Linear speed coefficient	0.1–999.9% Linear speed= Mechanical rotation speed×P07.10	1.0%	<input type="radio"/>
P07.11	Rectifier bridge module temperature	-4–248°F (-20.0–120.0°C)		<input checked="" type="radio"/>
P07.12	Converter module temperature	-4–248°F (-20.0–120.0°C)		<input checked="" type="radio"/>
P07.13	Software version	1.00–655.35		<input checked="" type="radio"/>
P07.14	Local accumulative running time	0–65535h		<input checked="" type="radio"/>
P07.15	High bit of power consumption	Display the power used by the inverter. The power consumption of the inverter =P07.15*1000+P07.16		<input checked="" type="radio"/>
P07.16	Low bit of power consumption	Setting range of P07.15: 0–65535 kWh (*1000) Setting range of P07.16: 0.0–999.9 kWh		<input checked="" type="radio"/>

Function code	Name	Detailed instruction of parameters	Default value	Modify
P07.17	Reserved	Reserved		●
P07.18	Rated power of the inverter	0.75–110kW (1–150HP)		●
P07.19	Rated voltage of the inverter	50–1200V		●
P07.20	Rated current of the inverter	0.1–6000.0A		●
P07.21	Factory bar code 1	0x0000–0xFFFF		●
P07.22	Factory bar code 2	0x0000–0xFFFF		●
P07.23	Factory bar code 3	0x0000–0xFFFF		●
P07.24	Factory bar code 4	0x0000–0xFFFF		●
P07.25	Factory bar code 5	0x0000–0xFFFF		●
P07.26	Factory bar code 6	0x0000–0xFFFF		●
P07.27	Type of present fault	0: No fault		●
P07.28	Type of the last fault	1: IGBT U phase protection (OUT1) 2: IGBT V phase protection (OUT2) 3: IGBT W phase protection (OUT3)		●
P07.29	Type of the last but one fault	4: OC1 5: OC2 6: OC3		●
P07.30	Type of the last but two fault	7: OV1 8: OV2 9: OV3		●
P07.31	Type of the last but three fault	10: UV 11: Motor overload (OL1) 12: The inverter overload (OL2)		●
P07.32	Type of the last but four fault	13: Input side phase loss (SPI) 14: Output side phase loss (SPO) 15: Overheat of the rectifier module (OH1) 16: Overheat fault of the inverter module (OH2) 17: External fault (EF) 18: 485 communication fault (CE)		●

Function code	Name	Detailed instruction of parameters	Default value	Modify
		19: Current detection fault (ItE) 20: Motor autotune fault (tE) 21: EEPROM operation fault (EEP) 22: PID response offline fault (PIDE) 23: Braking unit fault (bCE) 24: Running time arrival (END) 25: Electrical overload (OL3) 26: Panel communication fault (PCE) 27: Parameter uploading fault (UPE) 28: Parameter downloading fault (DNE) 29: PROFIBUS communication fault (E-DP) 30: Ethernet communication fault (E-NET) 31: CANopen communication fault (E-CAN) 32: Grounding short circuit fault 1 (ETH1) 33: Grounding short circuit fault 2 (ETH2) 34: Speed deviation fault (dEu) 35: Maladjustment (STo) 36: Undervoltage fault (LL)		
P07.33	Running frequency at present fault		0.00Hz	●
P07.34	Ramp reference frequency at present fault		0.00Hz	
P07.35	Output voltage at the present fault		0V	
P07.36	Output current at present fault		0.0A	
P07.37	Bus voltage at present fault		0.0V	
P07.38	The max temperature at present fault		32°F (0.0°C)	
P07.39	Input terminals state at present fault		0	●
P07.40	Output terminals state at present fault		0	●
P07.41	Running frequency at the last fault		0.00Hz	●
P07.42	Ramp reference frequency at the last fault		0.00Hz	●
P07.43	Output voltage at the last fault		0V	●
P07.44	The output current at the last fault		0.0A	●
P07.45	Bus voltage at the last fault		0.0V	●
P07.46	The max temperature at the last fault		32°F (0.0°C)	●
P07.47	Input terminals state at the last fault		0	●
P07.48	Output terminals state at the last fault		0	●
P07.49	Running frequency at the last but one fault		0.00Hz	●
P07.50	Output voltage at the last but one faults		0.00Hz	●

Function code	Name	Detailed instruction of parameters	Default value	Modify
P07.51	Output current at the last but one faults		0V	●
P07.52	Output current at the last but one fault		0.0A	●
P07.53	Bus voltage at the last but one fault		0.0V	●
P07.54	The max temperature at the last but one fault		32°F (0.0°C)	●
P07.55	Input terminals state at the last but one fault		0	●
P07.56	Output terminals state at the last but one fault		0	●
P08 Group Enhanced function				
P08.00	ACC time 2	See P00.11 and P00.12 for detailed definition. UMI-B5 UL series define four groups of ACC/DEC time which can be selected by P5 group. The first group of ACC/DEC time is the factory default one. Setting range: 0.0–3600.0s	Depend on model	○
P08.01	DEC time 2		Depend on model	○
P08.02	ACC time 3		Depend on model	○
P08.03	DEC time 3		Depend on model	○
P08.04	ACC time 4		Depend on model	○
P08.05	DEC time 4		Depend on model	○
P08.06	Jogging frequency	This parameter is used to define the reference frequency during jogging. Setting range: 0.00Hz –P00.03 (the max frequency)	5.00Hz	○
P08.07	Jogging ACC time	The jogging ACC time means the time needed if the inverter runs from 0Hz to the max Frequency.	Depend on model	○
P08.08	Jogging DEC time	The jogging DEC time means the time needed if the inverter goes from the max frequency (P0.03) to 0Hz. Setting range: 0.0–3600.0s	Depend on model	○
P08.09	Jumping frequency 1	When the set frequency is in the range of jumping frequency, the inverter will run at the edge of the jumping frequency. The inverter can avoid the mechanical resonance point by setting the jumping frequency. The inverter can set three jumping frequency. But this function will be invalid if all jumping points are 0.	0.00Hz	○
P08.10	Jumping frequency range 1		0.00Hz	○
P08.11	Jumping frequency 2		0.00Hz	○
P08.12	Jumping frequency range 2		0.00Hz	○
P08.13	Jumping frequency 3		0.00Hz	○

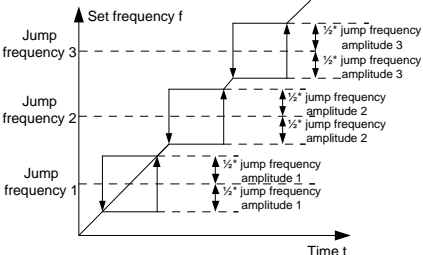
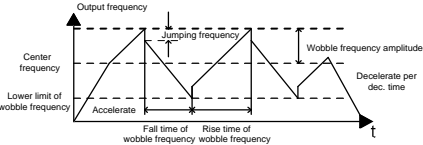
Function code	Name	Detailed instruction of parameters	Default value	Modify
P08.14	Jumping frequency range 3	 <p>Setting range: 0.00Hz –P00.03 (the max frequency)</p>	0.00Hz	○
P08.15	Traverse range	This function applies to the industries where traverse and convolution function are required such as textile and chemical fiber.	0.0%	○
P08.16	Sudden jumping frequency range	The traverse function means that the output frequency of the inverter is fluctuated with the set frequency as its center. The route of the running frequency is illustrated as below, of which the traverse is set by P08.15 and when P08.15 is set as	0.0%	○
P08.17	Traverse boost time	0, the traverse is 0 with no function.	5.0s	○
P08.18	Traverse declining time	 <p>Traverse range: The traverse running is limited by upper and low frequency.</p> <p>The traverse range relative to the center frequency: $\text{traverse range AW} = \text{center frequency} \times \text{traverse range P08.15}$.</p> <p>Sudden jumping frequency = $\text{traverse range AW} \times \text{sudden jumping frequency range P08.16}$. When run at the traverse frequency, the value which is relative to the sudden jumping frequency.</p> <p>The raising time of the traverse frequency: The time from the lowest point to the highest one.</p> <p>The declining time of the traverse frequency: The time from the highest point to the lowest one.</p> <p>Setting range of P08.15: 0.0–100.0% (relative to the set frequency)</p>	5.0s	○

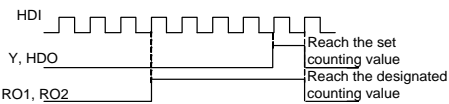
Function code	Name	Detailed instruction of parameters	Default value	Modify
		Setting range of P08.16: 0.0–50.0% (relative to the traverse range) Setting range of P08.17: 0.1–3600.0s Setting range of P08.18: 0.1–3600.0s		
P08.19	Setting length	The function codes of setting length, actual length and unit pulse are mainly used to control the fixed length. The length is counted by the pulse signal of HDI terminals input and the HDI terminals are needed to set as the length counting input. Actual length=the length counting input pulse /unit pulse When the actual length P08.20 exceeds the setting length P08.19, the multi-function digital output terminals will output ON. Setting range of P08.19: 0–65535m Setting range of P08.20: 0–65535m Setting range of P08.21: 1–10000 Setting range of P08.22: 0.01–100.00cm Setting range of P08.23: 0.001–10.000 Setting range of P08.24: 0.001–1.000	0ft (0m)	<input type="radio"/>
P08.20	Actual length		0ft (0m)	<input checked="" type="radio"/>
P08.21	Pulse per rotation		1	<input type="radio"/>
P08.22	Axle perimeter		10.00cm	<input type="radio"/>
P08.23	Length ratio		1.000	<input type="radio"/>
P08.24	Length correcting coefficient		1.000	<input type="radio"/>
P08.25	Setting counting value	The counter works by the input pulse signals of the HDI terminals.	0	<input type="radio"/>
P08.26	Reference counting value	When the counter achieves a fixed number, the multi-function output terminals will output the signal of “fixed counting number arrival” and the counter go on working; when the counter achieves a setting number, the multi-function output terminals will output the signal of “setting counting number arrival”, the counter will clear all numbers and stop to recount before the next pulse. The setting counting value P08.26 should be no more than the setting counting value P08.25. The function is illustrated as below:  Setting range of P08.25: P08.26–65535	0	<input type="radio"/>

Function code	Name	Detailed instruction of parameters	Default value	Modify
		Setting range of P08.26: 0–P08.25		
P08.27	Set running time	Pre-set running time of the inverter. When the accumulative running time achieves the set time, the multi-function digital output terminals will output the signal of “running time arrival”. Setting range: 0–65535min	0min	○
P08.28	Fault reset times	Fault reset times: set the automatic fault reset times. If the reset time exceeds this set value, the inverter will stop to wait maintenance.	0	○
P08.29	Interval time of automatic fault reset	Interval time of automatic fault reset: the interval between the time when the fault occurs and the time when the reset action occurs. Setting range of P08.28: 0–10 Setting range of P08.29: 0.1–3600.0s	1.0s	○
P08.30	Frequency decreasing ratio of the dropping control	The output frequency of the inverter changes as the load. And it is mainly used to balance the power when several inverters drive one load. Setting range: 0.00–50.00Hz	0.00Hz	○
P08.31	Motor shifting	UMI-B5 UL supports the shift between two motors. This function is used to select the shifting channel. LED ones: shifting channel 0: terminal shifting; digital terminal is 35 1: MODBUS communication shifting 2: PROFIBUS/CANopen communication shifting 3: Ethernet communication shifting 4: Reserved LED tens: shifting enabling in operation 0: Disabled 1: Enabled 0x00–0x14	0	◎
P08.32	FDT1 electrical level detection value	When the output frequency exceeds the corresponding frequency of FDT electrical level, the multi-function digital output terminals will output the signal of “frequency level detect FDT” until the output	60.00Hz	○
P08.33	FDT1 retention detection	frequency decreases to a value lower than (FDT electrical level—FDT retention detection value) the corresponding frequency, the signal is invalid. Below	5.0%	○

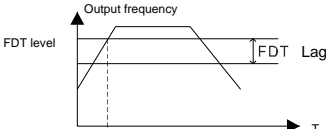
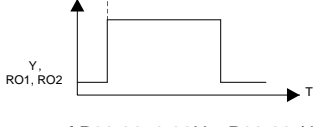
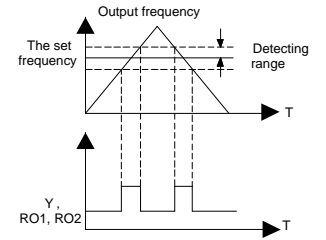
Function code	Name	Detailed instruction of parameters	Default value	Modify
	value	is the wave form diagram:		
P08.34	FDT2 electrical level detection value		60.00Hz	<input type="radio"/>
P08.35	FDT2 retention detection value	 <p>Setting range of P08.32: 0.00Hz–P00.03 (the max frequency) Setting range of P08.33: 0.0–100.0% (FDT1 electrical level) Setting range of P08.34: 0.00Hz–P00.03 (the max frequency) Setting range of P08.35: 0.0–100.0% (FDT2 electrical level)</p>	5.0%	<input type="radio"/>
P08.36	Frequency arrival detection range	<p>When the output frequency is among the positive or negative detection range of the set frequency, the multi-function digital output terminal will output the signal of “frequency arrival”, see the diagram below for detailed information:</p>  <p>The setting range: 0.00Hz–P00.03 (the max frequency)</p>	0.00Hz	<input type="radio"/>
P08.37	Energy braking enable	<p>This parameter is used to control the internal braking pipe inside the inverter.</p> <p>0: Disable 1: Enable</p> <p>Note: Only applied to internal braking pipe.</p>	0	<input type="radio"/>

Function code	Name	Detailed instruction of parameters	Default value	Modify			
P08.38	Threshold voltage	After setting the original bus voltage to brake the energy, adjust the voltage appropriately to brake the load. The factory changes with the voltage level. The setting range: 200.0–2000.0V In order to prevent customers set the value is too large, it is recommended setting range:	220V voltage: 380.0V	○			
		<table border="1"> <tr> <td>Voltage</td> <td>220V</td> <td>460V</td> </tr> <tr> <td>Range</td> <td>360-390V</td> <td>715–780V</td> </tr> </table>	Voltage		220V	460V	Range
Voltage	220V	460V					
Range	360-390V	715–780V					
P08.39	Cooling fan running mode	0: Normal mode 1: The fan keeps running after power on	0	○			
P08.40	PWM selection	0x00–0x21 LED ones: PWM mode selection 0: PWM mode 1, three-phase modulation and two-modulation 1: PWM mode 2, three-phase modulation LED tens: low-speed carrier frequency limit mode 0: Low-speed carrier frequency limit mode 1, the carrier frequency will limit to 2k if it exceeds 2k at low speed 1: Low-speed carrier frequency limit mode 2, the carrier frequency will limit to 4k if it exceeds 4k at low speed 2: No limit	01	◎			
P08.41	Overmodulation selection	LED ones 0: Invalid 1: Valid LED tens (for factory commissioning) 0: Light overmodulation; in zone 1 1: Heavy overmodulation; in zone 2	01	◎			
P08.42	Keypad data control	0x000–0x1223 LED ones: frequency enable selection 0: Both \wedge/\vee keys and digital potentiometer adjustments are valid 1: Only \wedge/\vee keys adjustment is valid 2: Only digital potentiometer adjustments is valid 3: Neither \wedge/\vee keys nor digital potentiometer adjustments are valid LED tens: frequency control selection	0x0000	○			

Function code	Name	Detailed instruction of parameters	Default value	Modify
		0: Only valid when P00.06=0 or P00.07=0 1: Valid for all frequency setting manner 2: Invalid for multi-step speed when multi-step speed has the priority LED hundreds: action selection during stopping 0: Setting is valid 1: Valid during running, cleared after stopping 2: Valid during running, cleared after receiving the stop command LED thousands: \wedge/\vee keys and digital potentiometer integral function 0: The integral function is valid 1: The integral function is invalid		
P08.43	Integral ratio of the keypad potentiometer	0.01–10.00s	0.10s	<input type="radio"/>
P08.44	UP/DOWN terminals control	0x000–0x221 LED ones: frequency control selection 0: UP/DOWN terminals setting valid 1: UP/DOWN terminals setting valid LED tens: frequency control selection 0: Only valid when P00.06=0 or P00.07=0 1: All frequency means are valid 2: When the multi-step are priority, it is invalid to the multi-step LED hundreds: action selection when stop 0: Setting valid 1: Valid in the running, clear after stop 2: Valid in the running, clear after receiving the stop commands	0x000	<input type="radio"/>
P08.45	UP terminals frequency changing ratio	0.01–50.00Hz/s	0.50 Hz/s	<input type="radio"/>
P08.46	DOWN terminals frequency changing ratio	0.01–50.00 Hz/s	0.50 Hz/s	<input type="radio"/>
P08.47	Frequency setting at	0x000–0x111 LED ones: Action selection when power off.	0x000	<input type="radio"/>

Function code	Name	Detailed instruction of parameters	Default value	Modify
	power loss	0: Save when power off 1: Clear when power off LED tens: Action selection when MODBUS set frequency off 0: Save when power off 1: Clear when power off LED hundreds: The action selection when other frequency set frequency off 0: Save when power off 1: Clear when power off		
P08.48	High bit of initial power consumption	This parameter is used to set the original value of the power consumption. The original value of the power consumption = $P08.48 * 1000 + P08.49$	0 kWh	<input type="radio"/>
P08.49	Low bit of initial power consumption	Setting range of P08.48: 0–59999 kWh (k) Setting range of P08.49: 0.0–999.9 kWh	0.0 kWh	<input type="radio"/>
P08.50	Magnetic flux braking	This function code is used to enable magnetic flux. 0: Invalid. 100–150: The bigger the coefficient, the stronger the braking is. This inverter is used to increase the magnetic flux to decelerate the motor. The energy generated by the motor during braking can be converted into heat energy by increasing the magnetic flux. The inverter monitors the state of the motor continuously even during the magnetic flux period. So the magnetic flux can be used in the motor stop, as well as to change the rotation speed of the motor. Its other advantages are: Brake immediately after the stop command. It does not need to wait the magnetic flux weaken. Better cooling for motors. The current of the stator other than the rotor increases during magnetic flux braking, while the cooling of the stator is more effective than the rotor.	0	<input checked="" type="radio"/>
P08.51	Current adjustment coefficient on the input side	This function code is used to adjust the displayed current of the AC input side. Setting range: 0.00–1.00	0.56	<input type="radio"/>

Function code	Name	Detailed instruction of parameters	Default value	Modify
P09 Group PID control				
P09.00	PID reference source	<p>When the frequency command selection (P00.06, P00.07) is 7 or the voltage setting channel selection (P04.27) is 6, the running mode of the inverter is procedure PID controlled.</p> <p>The parameter determines the target given channel during the PID procures.</p> <p>0: Keypad (P09.01) 1: AI1 2: AI2 3: AI3 4: HDI 5: Multi-step speed set 6: MODBUS communication set 7: PROFIBUS/CANopen communication set 8: Ethernet communication set 9: Reserved</p> <p>The setting target of procedure PID is a relative one, 100% of the setting equals to 100% of the response of the controlled system.</p> <p>The system is calculated according to the relative value (0–100.0%).</p> <p>Note: Multi-step speed given, it is realized by setting PA group parameters. PROFIBUS, Ethernet and CANopen communication setting need corresponding extension cards.</p>	0	<input type="radio"/>
P09.01	Keypad PID preset	<p>When P09.00=0, set the parameter whose basic value is the response value of the system.</p> <p>The setting range: -100.0%–100.0%</p>	0.0%	<input type="radio"/>
P09.02	PID feedback source	<p>Select the PID channel by the parameter.</p> <p>0: AI1 1: AI2 2: AI3 3: HDI 4: MODBUS communication feedback 5: PROFIBUS/CANopen communication feedback 6: Ethernet communication feedback 7: Reserved</p>	0	<input type="radio"/>

Function code	Name	Detailed instruction of parameters	Default value	Modify
		Note: The reference and feedback channel cannot coincide, otherwise, PID cannot control effectively.		
P09.03	PID output feature	0: PID output is positive: when the feedback signal exceeds the PID given value, the output frequency of the inverter will decrease to balance the PID. For example, the strain PID control during wrap-up 1: PID output is negative: When the feedback signal is stronger than the PID given value, the output frequency of the inverter will increase to balance the PID. For example, the strain PID control during wrap-down.	0	<input type="radio"/>
P09.04	Proportional gain (Kp)	The function is applied to the proportional gain P of PID input. P determines the strength of the whole PID adjuster. The parameter of 100 means that when the offset of PID feedback and given value is 100%, the adjusting range of PID adjuster is the max frequency (ignoring integral and differential function). The setting range: 0.00–100.00	1.00	<input type="radio"/>
P09.05	Integral time (Ti)	This parameter determines the speed of PID adjuster to carry out integral adjustment on the deviation of PID feedback and reference. When the deviation of PID feedback and reference is 100%, the integral adjuster works continuously after the time (ignoring the proportional effect and differential effect) to achieve the max Frequency (P00.03) or the max Voltage (P04.31). Shorter the integral time, stronger is the adjustment. Setting range: 0.00–10.00s	0.10s	<input type="radio"/>
P09.06	Differential time (Td)	This parameter determines the strength of the change ratio when PID adjuster carries out integral adjustment on the deviation of PID feedback and reference. If the PID feedback changes 100% during the time, the adjustment of integral adjuster (ignoring the proportional effect and differential effect) is the max Frequency (P00.03) or the max Voltage (P04.31).	0.00s	<input type="radio"/>

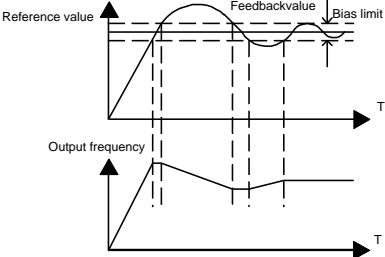
Function code	Name	Detailed instruction of parameters	Default value	Modify
		Longer the integral time, stronger is the adjusting. Setting range: 0.00–10.00s		
P09.07	Sampling cycle (T)	This parameter means the sampling cycle of the feedback. The adjustor operates each sampling cycle. The longer the sapling cycle is, the slower the response is. Setting range: 0.000–10.000s	0.100s	○
P09.08	PID control deviation limit	The output of PID system is the maximum deviation relative to close loop reference. As shown in the diagram below, PID adjustor stops to work during the deviation limit. Set the function properly to adjust the accuracy and stability of the system.  Setting range: 0.0–100.0%	0.0%	○
P09.09	Output upper limit of PID	This parameter is used to set the upper and lower limit of the PID adjustor output.	100.0%	○
P09.10	Output lower limit of PID	100.0 % corresponds to max frequency or the max voltage of (P04.31) Setting range of P09.09: P09.10–100.0% Setting range of P09.10: -100.0%–P09.09	0.0%	○
P09.11	Detection value of feedback offline	Set the detection value of feedback offline, when the feedback detection value is smaller than or equals to the detected value, and the lasting time exceeds the set value in P09.12, the inverter will report “PID feedback offline fault” and the keypad will display PIDE.	0.0%	○
P09.12	Detection time of feedback offline		1.0s	○

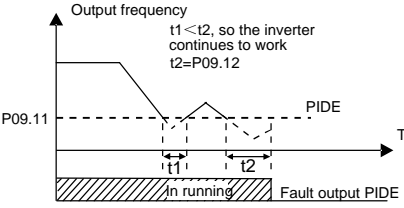
Function code	Name	Detailed instruction of parameters	Default value	Modify
		 <p>Setting range of P09.11: 0.0–100.0%</p> <p>Setting range of P09.12: 0.0–3600.0s</p>		
P09.13	PID adjustment	<p>0x0000–0x1111</p> <p>LED ones:</p> <p>0: Keep on integral adjustment when the frequency achieves the upper and low limit; the integration shows the change between the reference and the feedback unless it reaches the internal integral limit. When the trend between the reference and the feedback changes, it needs more time to offset the impact of continuous working and the integration will change with the trend.</p> <p>1: Stop integral adjustment when the frequency achieves the upper and low limit. If the integration keeps stable, and the trend between the reference and the feedback changes, the integration will change with the trend quickly.</p> <p>LED tens: P00.08 is 0</p> <p>0: The same with the setting direction; if the output of PID adjustment is different from the current running direction, the internal will output 0 forcedly.</p> <p>1: Opposite to the setting direction</p> <p>LED hundreds: P00.08 is 0</p> <p>0: Limit to the maximum frequency</p> <p>1: Limit to frequency A</p> <p>LED thousands:</p> <p>0: A+B frequency, the buffer of A frequency is invalid</p> <p>1: A+B frequency, the buffer of A frequency is valid</p> <p>ACC/DEC is determined by ACC time 4 of P08.04</p>	0x0001	○
P09.14	Proportional gain at low	0.00–100.00	1.00	○

Function code	Name	Detailed instruction of parameters	Default value	Modify
	frequency (Kp)			
P09.15	PID command of ACC/DEC time	0.0–1000.0s	0.0s	○
P09.16	PID output filter time	0.000–10.000s	0.000s	○
P10 Group Simple PLC and multi-step speed control				
P10.00	Simple PLC	0: Stop after running once. The inverter has to be commanded again after finishing a cycle. 1: Run at the final value after running once. After finish a signal, the inverter will keep the running frequency and direction of the last run. 2: Cycle running. The inverter will keep on running until receiving a stop command. And then, the system will stop.	0	○
P10.01	Simple PLC memory	0: Power loss without memory 1: Power loss with memory; PLC record the running stage and frequency when power loss.	0	○
P10.02	Multi-step speed 0	The frequency setting range of stage 0–15: -100.0–100.0%, 100.0% of the frequency setting corresponds to the max Frequency P00.03. The operation time setting of stage 0–15: the time unit is determined by P10.37. When selecting simple PLC running, set P10.02–P10.33 to define the running frequency and time of all stages. Note: The symbol of multi-step determines the running direction of simple PLC. The negative value means reverse rotation.	0.0%	○
P10.03	Running time of step 0		0.0s	○
P10.04	Multi-step speed 1		0.0%	○
P10.05	Running time of step 1		0.0s	○
P10.06	Multi-step speed 2		0.0%	○
P10.07	Running time of step 2		0.0s	○
P10.08	Multi-step speed 3		0.0%	○
P10.09	Running time of step 3		0.0s	○
P10.10	Multi-step speed 4		0.0%	○
P10.11	Running time of step 4		0.0s	○

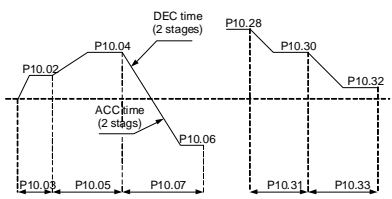

Function code	Name	Detailed instruction of parameters	Default value	Modify						
P10.12	Multi-step speed 5	<p>UMI-B5 UL series inverters can set 16 stages speed, selected by the combination of multi-step terminals 1-4 (select the setting by S terminals, the corresponding function codes are P05.01-P05.09), corresponding to the speed 1 to speed 15.</p>	0.0%	<input type="radio"/>						
P10.13	Running time of step 5		0.0s	<input type="radio"/>						
P10.14	Multi-step speed 6		0.0%	<input type="radio"/>						
P10.15	Running time of step 6		0.0s	<input type="radio"/>						
P10.16	Multi-step speed 7		0.0%	<input type="radio"/>						
P10.17	Running time of step 7		0.0s	<input type="radio"/>						
P10.18	Multi-step speed 8		0.0%	<input type="radio"/>						
P10.19	Running time of step 8		0.0s	<input type="radio"/>						
P10.20	Multi-step speed 9		<p>When terminal 1, terminal 2, terminal 3, terminal 4=OFF, the frequency input manner is selected via code P00.06 or P00.07. When terminal 1, terminal 2, terminal 3, terminal 4 aren't off, it runs at multi-step which takes precedence of keypad, analog value, high-speed pulse, PLC, communication frequency input.</p> <p>The relationship between terminal 1, terminal 2, terminal 3, terminal 4 and multi-step speed is as following:</p>	0.0%	<input type="radio"/>					
P10.21	Running time of step 9			0.0s	<input type="radio"/>					
P10.22	Multi-step speed 10			0.0%	<input type="radio"/>					
P10.23	Running time of step 10			0.0s	<input type="radio"/>					
P10.24	Multi-step speed 11			0.0%	<input type="radio"/>					
P10.25	Running time of step 11			Terminal 1	OFF	ON	OFF	ON	OFF	ON
				Terminal 2	OFF	OFF	ON	ON	OFF	OFF
P10.26	Multi-step speed 12	Terminal 3		OFF	OFF	OFF	OFF	ON	ON	ON
		Terminal 4		OFF	OFF	OFF	OFF	OFF	OFF	OFF
P10.27	Running time of step 12	Step		0	1	2	3	4	5	6
		Terminal 1	OFF	ON	OFF	ON	OFF	ON	OFF	ON
P10.28	Multi-step speed 13	Terminal 2	OFF	OFF	ON	ON	OFF	OFF	ON	ON
		Terminal 3	OFF	OFF	OFF	OFF	ON	ON	ON	ON
P10.29	Running time of step 13	Terminal 4	ON	ON	ON	ON	ON	ON	ON	ON
		Step	8	9	10	11	12	13	14	15
P10.30	Multi-step speed 14		0.0%	<input type="radio"/>						

Function code	Name	Detailed instruction of parameters	Default value	Modify																																																																																																									
P10.31	Running time of step 14		0.0s	○																																																																																																									
P10.32	Multi-step speed 15		0.0%	○																																																																																																									
P10.33	The running time of step 15		0.0s	○																																																																																																									
P10.34	Simple PLC 0-7 step ACC/DEC time	<p>Below is the detailed instruction:</p> <table border="1"> <thead> <tr> <th>Function code</th> <th>Binary bit</th> <th>Step</th> <th>ACC/DEC 0</th> <th>ACC/DEC 1</th> <th>ACC/DEC 2</th> <th>ACC/DEC 3</th> </tr> </thead> <tbody> <tr> <td rowspan="7">P10.34</td> <td>BIT1 BIT0</td> <td>0</td> <td>00</td> <td>01</td> <td>10</td> <td>11</td> </tr> <tr> <td>BIT3 BIT2</td> <td>1</td> <td>00</td> <td>01</td> <td>10</td> <td>11</td> </tr> <tr> <td>BIT5 BIT4</td> <td>2</td> <td>00</td> <td>01</td> <td>10</td> <td>11</td> </tr> <tr> <td>BIT7 BIT6</td> <td>3</td> <td>00</td> <td>01</td> <td>10</td> <td>11</td> </tr> <tr> <td>BIT9 BIT8</td> <td>4</td> <td>00</td> <td>01</td> <td>10</td> <td>11</td> </tr> <tr> <td>BIT11 BIT10</td> <td>5</td> <td>00</td> <td>01</td> <td>10</td> <td>11</td> </tr> <tr> <td>BIT13 BIT12</td> <td>6</td> <td>00</td> <td>01</td> <td>10</td> <td>11</td> </tr> <tr> <td>BIT15 BIT14</td> <td>7</td> <td>00</td> <td>01</td> <td>10</td> <td>11</td> </tr> <tr> <td rowspan="7">P10.35</td> <td>BIT1 BIT0</td> <td>8</td> <td>00</td> <td>01</td> <td>10</td> <td>11</td> </tr> <tr> <td>BIT3 BIT2</td> <td>9</td> <td>00</td> <td>01</td> <td>10</td> <td>11</td> </tr> <tr> <td>BIT5 BIT4</td> <td>10</td> <td>00</td> <td>01</td> <td>10</td> <td>11</td> </tr> <tr> <td>BIT7 BIT6</td> <td>11</td> <td>00</td> <td>01</td> <td>10</td> <td>11</td> </tr> <tr> <td>BIT9 BIT8</td> <td>12</td> <td>00</td> <td>01</td> <td>10</td> <td>11</td> </tr> <tr> <td>BIT11 BIT10</td> <td>13</td> <td>00</td> <td>01</td> <td>10</td> <td>11</td> </tr> <tr> <td>BIT13 BIT12</td> <td>14</td> <td>00</td> <td>01</td> <td>10</td> <td>11</td> </tr> <tr> <td>BIT15 BIT14</td> <td>15</td> <td>00</td> <td>01</td> <td>10</td> <td>11</td> </tr> </tbody> </table>	Function code	Binary bit	Step	ACC/DEC 0	ACC/DEC 1	ACC/DEC 2	ACC/DEC 3	P10.34	BIT1 BIT0	0	00	01	10	11	BIT3 BIT2	1	00	01	10	11	BIT5 BIT4	2	00	01	10	11	BIT7 BIT6	3	00	01	10	11	BIT9 BIT8	4	00	01	10	11	BIT11 BIT10	5	00	01	10	11	BIT13 BIT12	6	00	01	10	11	BIT15 BIT14	7	00	01	10	11	P10.35	BIT1 BIT0	8	00	01	10	11	BIT3 BIT2	9	00	01	10	11	BIT5 BIT4	10	00	01	10	11	BIT7 BIT6	11	00	01	10	11	BIT9 BIT8	12	00	01	10	11	BIT11 BIT10	13	00	01	10	11	BIT13 BIT12	14	00	01	10	11	BIT15 BIT14	15	00	01	10	11	0x0000	○
Function code	Binary bit	Step	ACC/DEC 0	ACC/DEC 1	ACC/DEC 2	ACC/DEC 3																																																																																																							
P10.34	BIT1 BIT0	0	00	01	10	11																																																																																																							
	BIT3 BIT2	1	00	01	10	11																																																																																																							
	BIT5 BIT4	2	00	01	10	11																																																																																																							
	BIT7 BIT6	3	00	01	10	11																																																																																																							
	BIT9 BIT8	4	00	01	10	11																																																																																																							
	BIT11 BIT10	5	00	01	10	11																																																																																																							
	BIT13 BIT12	6	00	01	10	11																																																																																																							
BIT15 BIT14	7	00	01	10	11																																																																																																								
P10.35	BIT1 BIT0	8	00	01	10	11																																																																																																							
	BIT3 BIT2	9	00	01	10	11																																																																																																							
	BIT5 BIT4	10	00	01	10	11																																																																																																							
	BIT7 BIT6	11	00	01	10	11																																																																																																							
	BIT9 BIT8	12	00	01	10	11																																																																																																							
	BIT11 BIT10	13	00	01	10	11																																																																																																							
	BIT13 BIT12	14	00	01	10	11																																																																																																							
BIT15 BIT14	15	00	01	10	11																																																																																																								
P10.35	Simple PLC 8-15 step ACC/DEC time	<p>After users select the corresponding ACC/DEC time, the combining 16 binary bit can be changed into hexadecimal bit, and then set the corresponding function codes.</p> <p>ACC/DEC time 1 is set by P00.11 and P00.12; ACC/DEC time 2 is set by P08.00 and P08.01; ACC/DEC time 3 is set by P08.02 and P08.03; ACC/DEC time 4 is set by P08.04 and P08.05.</p> <p>Setting range: -0x0000-0xFFFF</p>	0x0000	○																																																																																																									
P10.36	PLC restart	<p>0: Restart from the first step; stop during running (caused by the stop command, fault or power loss), run from the first stage after restart.</p> <p>1: Continue to run from the stop frequency; stop</p>	0	◎																																																																																																									

Function code	Name	Detailed instruction of parameters	Default value	Modify						
		during running (caused by stop command and fault), the inverter will record the running time automatically, enter into the stage after restart and keep the remaining running at the setting frequency.								
P10.37	Multi-step time unit	0: Seconds; the running time of all steps is counted by second 1: Minutes; the running time of all steps is counted by minute	0	⊙						
P11 Group Protective parameters										
P11.00	Phase loss protection	0x00–0x11 LED ones: 0: Input phase loss protection disable 1: Input phase loss protection enable LED tens: 0: Output phase loss protection disable 1: Output phase loss protection enable	11	○						
P11.01	Frequency-decreasing at sudden power loss	0: Enable 1: Disable	0	○						
P11.02	Frequency decreasing ratio at sudden power loss	Setting range: 0.00Hz/s–P00.03 (the max frequency) After the power loss of the grid, the bus voltage drops to the sudden frequency-decreasing point, the inverter begin to decrease the running frequency at P11.02, to make the inverter generate power again. The returning power can maintain the bus voltage to ensure a rated running of the inverter until the recovery of power. <table border="1" style="margin-left: auto; margin-right: auto;"> <tr> <td>Voltage degree</td> <td>220V</td> <td>460V</td> </tr> <tr> <td>Frequency-decreasing threshold</td> <td>260V</td> <td>530V</td> </tr> </table> <p>Note: 1. Adjust the parameter properly to avoid the stopping caused by inverter protection during the switching of the grid. 2. Prohibition of input phase protection can enable this function.</p>	Voltage degree	220V	460V	Frequency-decreasing threshold	260V	530V	10.00Hz/s	○
Voltage degree	220V	460V								
Frequency-decreasing threshold	260V	530V								
P11.03	Overvoltage	0: Disable	1	○						

Function code	Name	Detailed instruction of parameters	Default value	Modify
	stall protection	1: Enable 		
P11.04	Voltage protection of overvoltage stall	110–150% (standard bus voltage) (220V)	120%	○
		120–150% (standard bus voltage) (460V)	136%	
P11.05	Current limit action selection	The actual increasing ratio of motor speed is lower than the ratio of output frequency because of the big load during ACC running. It is necessary to take measures to avoid overcurrent fault and inverter tripping. Ones: current limit: 0: Invalid 1: Valid Tens: overload alarm of hardware current limit (for factory commissioning) 0: Valid 1: Invalid	01	◎
P11.06	Automatic current limit	During the running of the inverter, it will detect the output current and compare it with the limit level defined in P11.06. If it exceeds the level, the inverter will run at stable frequency in ACC running, or the inverter will derate to run during the constant	160.0%	◎
P11.07	Frequency-decreasing ratio during current limit	running. If it exceeds the level continuously, the output frequency will keep on decreasing to the lower limit. If the output current is detected to be lower than the limit level, the inverter will accelerate to run.	10.00Hz/s	◎

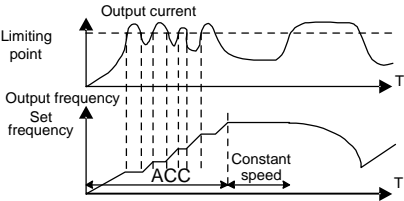
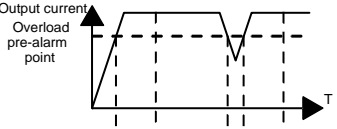
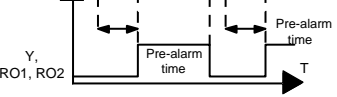
Function code	Name	Detailed instruction of parameters	Default value	Modify
		 <p>Setting range of P11.06: 50.0–200.0%</p> <p>Setting range of P11.07: 0.00–50.00Hz/s</p>		
P11.08	Overload pre-alarm of motor/ inverter	The output current of the inverter or the motor is above P11.09 and the lasting time is beyond P11.10, overload pre-alarm will be output.	0x000	○
P11.09	Overload pre-alarm detection		150%	○
P11.10	Overload pre-alarm detection time	 <p>Setting range of P11.08: Enable and define the overload pre-alarm of the inverter or the motor. Setting range: 0x000–0x131 LED ones: 0: Overload pre-alarm of the motor, relative to the rated current of the motor 1: Overload pre-alarm of the inverter, relative to the rated current of the inverter LED tens: 0: The inverter continues to work after underload pre-alarm 1: The inverter continues to work after underload pre-alarm and the inverter stops to run after overload fault 2: The inverter continues to work after overload pre-alarm and the inverter stops to run after</p>	1.0s	○

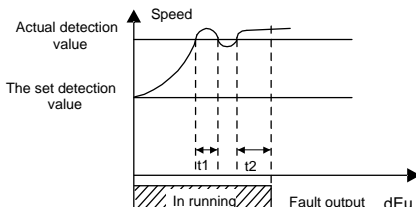
Function code	Name	Detailed instruction of parameters	Default value	Modify
		underload fault LED hundreds: 0: Detection all the time 1: Detection in constant running Setting range of P11.09: P11.11–200% Setting range of P11.10: 0.1–3600.0s		
P11.11	Underload pre-alarm detection	If the inverter current or the output current is lower than P11.11, and its lasting time is beyond P11.12, the inverter will output underload pre-alarm.	50%	<input type="radio"/>
P11.12	Underload pre-alarm detection time	Setting range of P11.11: 0–P11.09 Setting range of P11.12: 0.1–3600.0s	1.0s	<input type="radio"/>
P11.13	Output terminal action during fault	Select the action of fault output terminals on undervoltage and fault reset. 0x00–0x11 LED ones: 0: Action under fault undervoltage 1: No action under fault undervoltage LED tens: 0: Action during the automatic reset 1: No action during the automatic reset	0x00	<input type="radio"/>
P11.14	Speed deviation detection	0.0–50.0% Set the speed deviation detection time.	10.0%	<input type="radio"/>
P11.15	Speed deviation detection time	This parameter is used to see the speed deviation detection time.  Setting range of P11.15: 0.0–10.0s	0.5s	<input type="radio"/>
P11.16	Automatic frequency-decreasing at rearing at	0: Invalid 1: Valid; ensure rated output torque when voltage drop	0	<input type="radio"/>

Function code	Name	Detailed instruction of parameters		Default value	Modify
	voltage drop				
P12 Group Motor 2					
P12.00	Motor type 2	0: Asynchronous motor 1: Synchronous motor Note: switch the current motor by the switching channel of P08.31.		0	⊙
P12.01	Rated power of asynchronous motor 2	0.75–110kW (1–150HP)	Set the parameter of the controlled asynchronous motor. In order to ensure the controlling performance, set the P12.01–P12.05 according to the name plate of the asynchronous motor. UMI-B5 UL series inverters provide the function of parameter autotuning. Correct parameter autotuning comes from the correct setting of the motor name plate. In order to ensure the controlling performance, configure the motor according to the standard principles, if the gap between the motor and the standard one is huge, the features of the inverter will decrease. Note: reset the rated power of the motor (P12.01), initialize the motor parameter of P12.02–P12.05	Depend on model	⊙
P12.02	Rated frequency of asynchronous motor 2	0.01Hz–P00.03 (the max frequency)		60.00Hz	⊙
P12.03	Rated speed of asynchronous motor 2	1–36000rpm		Depend on model	⊙
P12.04	Rated voltage of asynchronous motor 2	0–1200V		Depend on model	⊙
P12.05	Rated current of asynchronous motor 2	0.8–6000.0A		Depend on model	⊙
P12.06	Stator resistor of asynchronous	0.001–65.535Ω	After finish the motor parameter autotuning, the set value of P12.06–P12.10	Depend on model	○

Function code	Name	Detailed instruction of parameters		Default value	Modify
	motor 2		will renew automatically.		
P12.07	Rotor resistor of asynchronous motor 2	0.001–65.535Ω	These parameters are basic parameters controlled by vectors which directly impact the features. Note: Users cannot modify the parameters freely.	Depend on model	<input type="radio"/>
P12.08	Leakage inductance of asynchronous motor 2	0.1–655.35mH		Depend on model	<input type="radio"/>
P12.09	Mutual inductance of asynchronous motor 2	0.1–655.35mH		Depend on model	<input type="radio"/>
P12.10	Non-load current of asynchronous motor 2	0.1–6553.5A		Depend on model	<input type="radio"/>
P12.11	Magnetic saturation coefficient 1 for the iron core of AM2	0.0–100.0%		80.0%	<input checked="" type="radio"/>
P12.12	Magnetic saturation coefficient 2 for the iron core of AM2	0.0–100.0%	68.0%	<input checked="" type="radio"/>	
P12.13	Magnetic saturation coefficient 3 for the iron core of AM2	0.0–100.0%	57.0%	<input checked="" type="radio"/>	
P12.14	Magnetic saturation coefficient 4 for the iron core of AM2	0.0–100.0%	40.0%	<input checked="" type="radio"/>	
P12.15	Rated power	0.75–110kW	Set the parameter of the	Depend	<input checked="" type="radio"/>

Function code	Name	Detailed instruction of parameters		Default value	Modify
	of synchronous motor 2	(1–150HP)	controlled asynchronous motor. In order to ensure the	on model	
P12.16	Rated frequency of synchronous motor 2	0.01Hz–P00.03 (the max frequency)	controlling performance, set the P12.151–P12.19 according to the name plate of the asynchronous motor.	60.00Hz	☉
P12.17	Number of poles pairs for synchronous motor 2	1–50	UMI-B5 UL series inverters provide the function of parameter autotuning. Correct parameter	2	☉
P12.18	Rated voltage of synchronous motor 2	0–1200V	autotuning comes from the correct setting of the motor name plate.	Depend on model	☉
P12.19	Rated current of synchronous motor 2	0.8–6000.0A	In order to ensure the controlling performance, configure the motor according to the standard principles, if the gap	Depend on model	☉
P12.20	Stator resistor of synchronous motor 2	0.001–65.535Ω	between the motor and the standard one is huge, the features of the inverter will decrease. Note: reset the rated power of the motor (P12.15), initialize the motor parameter of P12.16–P12.19.	Depend on model	○
P12.21	Direct axis inductance of synchronous motor 2	0.01–655.35mH	After finish the motor parameter autotuning, the set value of P12.20–P12.22 will renew automatically.	Depend on model	○
P12.22	Quadrature axis inductance of synchronous motor 2	0.01–655.35mH	These parameters are basic parameters controlled by vectors which directly impact the features. When P00.15=1, the set	Depend on model	○
P12.23	Back EMF constant of	When P00.15=2, the set value of P12.23	value of P12.23 can be updated through autotuning	300	○

Function code	Name	Detailed instruction of parameters		Default value	Modify
	synchronous motor 2	<p>cannot be updated by autotuning, count according to the following method.</p> <p>The counter-electromotive force constant can be counted according to the parameters on the name plate of the motor. There are three ways to count:</p> <p>1. If the name plate designate the counter-electromotive force constant K_e, then: $E = (K_e \cdot n_N \cdot 2 \pi) / 60$</p> <p>2. If the name plate designate the counter-electromotive force constant E' (V/1000r/min), then: $E = E' \cdot n_N / 1000$</p> <p>3. If the name plate does not designate the above parameters, then: $E = P / \sqrt{3} \cdot I$</p> <p>In the above formulas: n_N is the rated rotation speed, P is the rated power and I is the rated current. Setting range: 0–10000</p>	<p>automatically, and there is no need to change the value of P12.23; when P00.15=2, the set value of P12.23 cannot be updated through autotuning, ccount and update the value of P12.23.</p> <p>Note: Users cannot modify the parameters freely.</p>		
P12.24	Initial pole position of synchronous	0-FFFFH (reserved)		0x0000	●

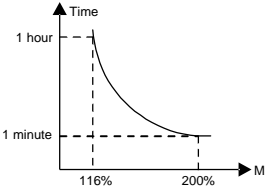
Function code	Name	Detailed instruction of parameters	Default value	Modify
	motor 2 (reserved)			
P12.25	Identification current of synchronous motor 2 (reserved)	0%–50% (the rated current of the motor) (reserved)	10%	●
P12.26	Motor 2 overload protection	0: No protection 1: Common motor (with low speed compensation) 2: Variable frequency motor (without low speed compensation)	2	◎
P12.27	Motor 2 overload protection coefficient	<p>Times of motor overload $M = I_{out}/(I_n * K)$ I_n is the rated current of the motor, I_{out} is the output current of the inverter and K is the motor protection coefficient.</p> <p>So, the bigger the value of K is, the smaller the value of M is. When $M = 116%$, the fault will be reported after 1 hour, when $M = 200%$, the fault will be reported after 1 minute, when $M \geq 400%$, the fault will be reported instantly.</p>  <p>Setting range: 20.0%–120.0%</p>	100.0%	○
P12.28	Correction coefficient of motor 2 power	Correct the power displaying of motor 2. Only impact the displaying value other than the control performance of the inverter. Setting range: 0.00–3.00	1.00	○
P12.29	Parameter display of motor 2	0: Display according to the motor type: only the parameters relative to the current motor type are displayed for the convenient for the customers in this mode. 1: All parameters are displayed: all parameters are displayed in this mode.	0	○

P13 Group Synchronous motor control

Function code	Name	Detailed instruction of parameters	Default value	Modify
P13.00	Reduction coefficient of source current	0.0–100.0%	80.0%	☉
P13.01	Original pole test mode	0: No test 1: High-frequency superposition (reserved) 2: Pulse superposition	0	☉
P13.02	Source current 1	Source current is the positioning current of the magnetic pole position. Source current 1 is valid under the frequency point of current shifting. Increasing the value can raise the starting torque. Setting range: 0.0%–100.0% (rated current of the motor)	20.0%	○
P13.03	Source current 2	Source current is directional current of the magnetic pole position. Source current 2 is valid under the frequency point of current shifting. There is no need to modify the value generally. Setting range: 0.0%–100.0% (rated motor current)	10.0%	○
P13.04	Shift frequency of source current	Valid frequency shifting point between source current 1 and current 2. Setting range: 0.00Hz–P00.03 (the max frequency)	10.00Hz	○
P13.05	Superposing frequency (reserved)	200–1000Hz	500Hz	☉
P13.06	Pulse superposing voltage	0.0–300.0% (rated voltage of the motor)	40.0%	☉
P13.07	Reserved	0–65535	0	○
P13.08	Control parameter 1	0–65535	0	○
P13.09	Control parameter 2	0–655.35	2.00	○
P13.10	Reserved	0–65535	0	○
P13.11	Maladjustment detection time	Adjust the response of anti-maladjustment. Bigger load inertia may increase the value, but the response will be slower. Setting range: 0.0–10.0s	0.5s	○
P13.12	High frequency	When the motor speed is faster than the rated speed, the parameter is valid, if vibration occurs to the	0.0%	○

Function code	Name	Detailed instruction of parameters	Default value	Modify
	compensation coefficient	motor, adjust the parameter. Setting range: 0–100.0%		
P13.13	Braking current of short-circuit	When P01.00=0 during the starting of the inverter, set P13.14 to a non-zero value to enter the short circuit braking.	0.0%	<input type="radio"/>
P13.14	Braking retention time before starting	When the running frequency is lower than P01.09 during the stopping of the inverter, set 13.15 to a non-zero value to enter into stopping short circuited braking and then carry out the DC braking at the time set by P01.12 (refer to the instruction of P01.09–P01.12) .	0.00s	<input type="radio"/>
P13.15	The braking retention time when stopping	Setting range of P13.13: 0.0–150.0% (the inverter) Setting range of P13.14: 0.00–50.00s Setting range of P13.15: 0.00–50.00s	0.00s	<input type="radio"/>
P14 Group Serial communication				
P14.00	Local communication address	The setting range: 1–247 When the master is writing the frame, the communication address of the slave is set to 0; the address is the communication address. All slaves on the MODBUS fieldbus can receive the frame, but the slave doesn't answer. The communication of the drive is unique in the communication net. This is the fundamental for the point to point communication between the upper monitor and the drive. Note: The address of the slave cannot set to 0.	1	<input type="radio"/>
P14.01	Communication baud ratio	Set the digital transmission speed between the upper monitor and the inverter. 0: 1200BPS 1: 2400BPS 2: 4800BPS 3: 9600BPS 4: 19200BPS 5: 38400BPS 6: 57600BPS 7: 115200BPS Note: The baud rate between the upper PC and the inverter must be the same. Otherwise, the communication is not applied. The bigger the baud	4	<input type="radio"/>

Function code	Name	Detailed instruction of parameters	Default value	Modify
		rate, the quicker the communication speed.		
P14.02	Digital bit checkout	The data format between the upper monitor and the inverter must be the same. Otherwise, the communication is not applied. 0: No check (N,8,1) for RTU 1: Even check (E,8,1) for RTU 2: Odd check (O,8,1) for RTU 3: No check (N,8,2) for RTU 4: Even check (E,8,2) for RTU 5: Odd check (O,8,2) for RTU	1	<input type="radio"/>
P14.03	Answer delay	0–200ms The interval time when the drive receives the data and sent it to the upper monitor. If the answer delay is shorter than the system processing time, then the answer delay time is the system processing time, if the answer delay is longer than the system processing time, then after the system deal with the data, waits until achieving the answer delay time to send the data to the upper monitor.	5	<input type="radio"/>
P14.04	Fault time of communication overtime	0.0 (invalid), 0.1–60.0s When the function code is set as 0.0, the communication overtime parameter is invalid. When the function code is set as non-zero, if the interval time between two communications exceeds the communication overtime, the system will report “485 communication faults” (CE). Generally, set it as invalid; set the parameter in the continuous communication to monitor the communication state.	0.0s	<input type="radio"/>
P14.05	Transmission fault processing	0: Alarm and stop freely 1: No alarm and continue to run 2: No alarm and stop according to the stop mode (only under the communication control) 3: No alarm and stop according to the stop mode (under all control modes)	0	<input type="radio"/>
P14.06	Communication processing	0x00–0x11 LED ones: 0: Write with response: the inverter will respond to all reading and writing commands of the upper monitor.	0x00	<input type="radio"/>

Function code	Name	Detailed instruction of parameters	Default value	Modify
		1: Write without response: the inverter only responds to the reading command other than the writing command of the drive. The communication efficiency can be increased by this method. LED tens: 0: Communication encrypting is invalid 1: Communication encrypting is valid		
P15 Group PROFIBUS/CANopen function				
P15.00	Module type	0: PROFIBUS 1: CANopen Select communication protocol	0	☉
P15.01	Module address	0-127 This function code is used to designate the address of the inverter. Note: 0 is the broadcast address, when set it as broadcast address, only receive the radio command of the upper monitor other than answering the upper monitor.	2	☉
P15.02	PZD2 receiving	0: Invalid	0	○
P15.03	PZD3 receiving	1: Setting frequency (0-Fmax (unit: 0.01Hz))	0	○
P15.04	PZD4 receiving	2: PID reference, range (0-1000, 1000 corresponds to 100.0%)	0	○
P15.05	PZD5 receiving	3: PID feedback, range (0-1000, 1000 corresponds to 100.0%)	0	○
P15.06	PZD6 receiving	4: Torque setting (-3000-3000, 1000 corresponds to 100.0% the rated current of the motor)	0	○
P15.07	PZD7 receiving	5: Upper frequency of forward rotation (0-Fmax (unit: 0.01Hz))	0	○
P15.08	PZD8 receiving	6: Upper frequency of reverse rotation (0-Fmax (unit: 0.01Hz))	0	○
P15.09	PZD9 receiving	7: Electromotion torque upper limit (0-3000, 1000 corresponds to 100.0%of the rated current of the motor)	0	○
P15.10	PZD10 receiving	8: Braking torque upper limit (0-2000, 1000 corresponds to 100.0% of the rated current of the motor)	0	○
P15.11	PZD11 receiving	9: Virtual input terminals command Range: 0x000-0x1FF	0	○

Function code	Name	Detailed instruction of parameters	Default value	Modify
P15.12	PZD12 receiving	10: Virtual output terminals command Range: 0x00–0x0F 11: Voltage setting value (special for V/F separation) (0–1000, 1000 corresponds to 100.0% the rated voltage of the motor) 12: AO output set value 1 (-1000–1000, 1000 corresponds to 100.0%) 13: AO output set value 2 (-1000–1000, 1000 corresponds to 100.0%) 14–20: Reserved	0	○
P15.13	PZD2 sending	0: Invalid	0	○
P15.14	PZD3 sending	1: Running frequency (*100, Hz)	0	○
P15.15	PZD4 sending	2: Setting frequency (*100, Hz)	0	○
P15.16	PZD5 sending	3: Bus voltage (*10, V)	0	○
P15.17	PZD6 sending	4: Output voltage (*1, V)	0	○
P15.18	PZD7 sending	5: Output current (*10, A)	0	○
P15.19	PZD8 sending	6: Output torque actual value (*10, %)	0	○
P15.20	PZD9 sending	7: Output power actual value (*10, %)	0	○
P15.21	PZD10 sending	8: Running rotating speed (*1, RPM)	0	○
P15.22	PZD11 sending	9: Running linear speed (*1, m/s)	0	○
P15.23	PZD12 sending	10: Ramp given frequency 11: Fault code 12: AI1 value (*100, V) 13: AI2 value (*100, V) 14: AI3 value (*100, V) 15: PULSE frequency value (*100, kHz) 16: Terminals input state 17: Terminals output state 18: PID given (*100, %) 19: PID feedback (*100, %) 20: Motor rated torque 21: Control word	0	○
P15.24	Temporarily variable 1 for PZD sending	0–65535	0	○
P15.25	Fault time of DP communication overtime	0.0 (invalid), 0.1–60.0s When this function code is set as 0.0, this function is invalid. When the function code is set as nonzero value, if	0.0s	○

Function code	Name	Detailed instruction of parameters	Default value	Modify
		the internal time between two adjacent communication exceeds the communication overtime, the system will report "PROFIBUS communication fault" (E-DP).		
P15.26	Fault time of CANopen communication overtime	0.0 (invalid), 0.1–60.0s When this function code is set as 0.0, this function is invalid. When the function code is set as nonzero value, if the internal time between two adjacent communication exceeds the communication overtime, the system will report "CANopen communication fault" (E-CAN)	0.0s	
P15.27	CANopen baud rate	0: 1000k 1: 800k 2: 500k 3: 250k 4: 125k 5: 100k 6: 50k 7: 20k	0	●
P16 Group Ethernet function				
P16.00	Speed setting of Ethernet communication	0: Self-adapting 1: 100M full duplex 2: 100M semiduplex 3: 10M full duplex 4: 10M semiduplex The function code is used to set the Ethernet communication speed.	0	⊙
P16.01	IP address 1	0–255	192	⊙
P16.02	IP address 2	Set the IP address of Ethernet communication	168	⊙
P16.03	IP address 3		The format of IP address: P16.09.P16.10.P16.11.P16.12 For example: IP address is 192.168.0.1.	0
P16.04	IP address 4		1	⊙
P16.05	Subnet mask 1	0–255	255	⊙
P16.06	Subnet mask 2	Set the subnet mask of Ethernet communication.	255	⊙
P16.07	Subnet mask 3		The format of IP subnet mask: P16.13.P16.14.P16.15.P16.16. For example: The mask is 255.255.255.0.	255
P16.08	Subnet mask 4		0	⊙

Function code	Name	Detailed instruction of parameters	Default value	Modify																				
P16.09	Gateway 1	0-255 Set the gateway of Ethernet communication	192	⊙																				
P16.10	Gateway 2		168	⊙																				
P16.11	Gateway 3		1	⊙																				
P16.12	Gateway 4		1	⊙																				
P17 Group Monitoring function																								
P17.00	Setting frequency	Display current set frequency of the inverter Range: 0.00Hz-P00.03	0.00Hz	●																				
P17.01	Output frequency	Display current output frequency of the inverter Range: 0.00Hz-P00.03	0.00Hz	●																				
P17.02	Ramp reference frequency	Display current ramp given frequency of the inverter Range: 0.00Hz-P00.03	0.00Hz	●																				
P17.03	Output voltage	Display current output voltage of the inverter Range: 0-1200V	0V	●																				
P17.04	Output current	Display current output current of the inverter Range: 0.0-3000.0A	0.0A	●																				
P17.05	Motor speed	Display the rotation speed of the motor. Range: 0-65535RPM	0 RPM	●																				
P17.06	Torque current	Display current torque current of the inverter Range: -3000.0-3000.0A	0.0A	●																				
P17.07	Exciting current	Display current exciting current of the inverter Range: -3000.0-3000.0A	0.0A	●																				
P17.08	Motor power	Display current power of the motor. Setting range: -300.0%-300.0% (rated motor current)	0.0%	●																				
P17.09	Output torque	Display the current output torque of the inverter. Range: -250.0-250.0%	0.0%	●																				
P17.10	Evaluated motor frequency	Evaluate the motor rotor frequency on close loop vector Range: 0.00- P00.03	0.00Hz	●																				
P17.11	DC bus voltage	Display current DC bus voltage of the inverter Range: 0.0-2000.0V	0.0V	●																				
P17.12	Digital input terminals state	Display current Switch input terminals state of the inverter <table border="1" style="margin-left: auto; margin-right: auto;"> <tr> <td></td> <td>BIT8</td> <td>BIT7</td> <td>BIT6</td> <td>BIT5</td> </tr> <tr> <td></td> <td>HDI</td> <td>S8</td> <td>S7</td> <td>S6</td> </tr> <tr> <td>BIT4</td> <td>BIT3</td> <td>BIT2</td> <td>BIT1</td> <td>BIT0</td> </tr> <tr> <td>S5</td> <td>S4</td> <td>S3</td> <td>S2</td> <td>S1</td> </tr> </table> Range: 0000-01FF		BIT8	BIT7	BIT6	BIT5		HDI	S8	S7	S6	BIT4	BIT3	BIT2	BIT1	BIT0	S5	S4	S3	S2	S1	0	●
	BIT8	BIT7	BIT6	BIT5																				
	HDI	S8	S7	S6																				
BIT4	BIT3	BIT2	BIT1	BIT0																				
S5	S4	S3	S2	S1																				

Function code	Name	Detailed instruction of parameters	Default value	Modify								
P17.13	Digital output terminals state	Display current Switch output terminals state of the inverter <table border="1" style="margin-left: auto; margin-right: auto;"> <tr> <td style="text-align: center;">BIT3</td> <td style="text-align: center;">BIT2</td> <td style="text-align: center;">BIT1</td> <td style="text-align: center;">BIT0</td> </tr> <tr> <td style="text-align: center;">RO2</td> <td style="text-align: center;">RO1</td> <td style="text-align: center;">HDO</td> <td style="text-align: center;">Y</td> </tr> </table> Range: 0000–000F	BIT3	BIT2	BIT1	BIT0	RO2	RO1	HDO	Y	0	●
BIT3	BIT2	BIT1	BIT0									
RO2	RO1	HDO	Y									
P17.14	Digital adjustment	Display the adjustment through the keypad of the inverter. Range : 0.00Hz–P00.03	0.00Hz	●								
P17.15	Torque reference	Display the torque given, the percentage to the current rated torque of the motor. Setting range: -300.0%–300.0% (rated motor current)	0.0%	●								
P17.16	Linear speed	Display the current linear speed of the inverter. Range: 0–65535	0	●								
P17.17	Length	Display the current length of the inverter. Range: 0–65535	0	●								
P17.18	Counting value	Display the current counting number of the inverter. Range: 0–65535	0	●								
P17.19	AI1 input voltage	Display analog AI1 input signal Range: 0.00–10.00V	0.00V	●								
P17.20	AI2 input voltage	Display analog AI2 input signal Range: 0.00–10.00V	0.00V	●								
P17.21	AI3 input voltage	Display analog AI2 input signal Range: -10.00–10.00V	0.00V	●								
P17.22	HDI input frequency	Display HDI input frequency Range: 0.000–50.000kHz	0.000 kHz	●								
P17.23	PID reference	Display PID given value Range: -100.0–100.0%	0.0%	●								
P17.24	PID feedback	Display PID response value Range: -100.0–100.0%	0.0%	●								
P17.25	Power factor of the motor	Display the current power factor of the motor. Range: -1.00–1.00	0.0	●								
P17.26	Current running time	Display the current running time of the inverter. Range: 0–65535m	0m	●								
P17.27	Simple PLC and the current step of the multi-step speed	Display simple PLC and the current stage of the multi-step speed Range: 0–15	0	●								

Function code	Name	Detailed instruction of parameters	Default value	Modify
P17.28	ASR controller output	The percentage of the rated torque of the relative motor, display ASR controller output Range: -300.0%–300.0% (rated motor current)	0.0%	●
P17.29	Magnetic pole angle of SM	Display synchronous motor Magnetic pole angle Range: 0.0–360.0	0.0	●
P17.30	Phase compensation of SM	Display synchronous motor phase compensation Range: -180.0–180.0	0.0	●
P17.31	High-frequency superimposed current of SM	Display synchronous motor high-frequency Superimposed current Range: 0.0%–200.0% (rated motor current)	0.0	●
P17.32	Magnetic flux linkage	Display the magnetic flux linkage of the motor. Range: 0.0%–200.0%	0.0%	●
P17.33	Exciting current reference	Display the exciting current reference in the vector control mode. Range: -3000.0–3000.0A	0.0A	●
P17.34	Torque current reference	Display the torque current reference in the vector control mode. Range: -3000.0–3000.0A	0.0A	●
P17.35	AC current	Display the value of inlet current in AC side. Range: 0.0–5000.0A	0.0A	●
P17.36	Output torque	Display the output torque. Positive value is in the electromotion state, and negative is in the power generating state. Range: -3000.0Nm to 3000.0Nm	0.0Nm	●
P17.37	Count value of motor overload	0–100 (100 reports OL1 fault)	0	●
P17.38	PID output	-100.00–100.00%	0.00%	●
P17.39	Wrong download of parameters	0.00–99.99	0.00	●

7 Basic operation instruction

7.1 What this chapter contains

This chapter describes the internal function mode of the inverter in details.

	<ul style="list-style-type: none"> ◇ Check all terminals are connected properly and tightly. ◇ Check that the power of the motor corresponds to that of the inverter.
---	---

7.2 First powering on

Check before powering on

Check according to the installation list in chapter two.

Original powering operation

Check to ensure there is no mistake in wiring and power supply, switch on the air switch of the AC power supply on the input side of the inverter to power on the inverter. 8.8.8.8.8 will be displayed on the keypad, and the contactor closes normally. When the character on the nixie tube changes to the set frequency, the inverter has finished the initialization and it is in the stand-by state.

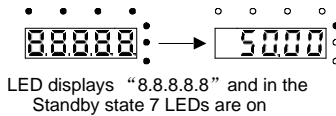

Below diagram shows the first operation: (take motor 1 as the example)

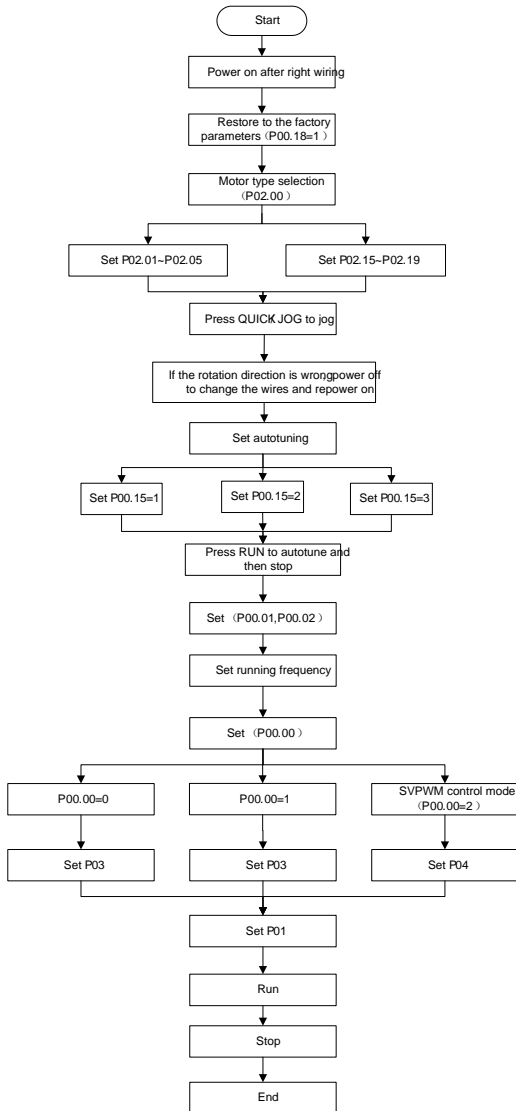

Note: If fault occurs, do as the “Fault Tracking”. Estimate the fault reason and settle the issue.

Besides P00.01 and P00.02, terminal command setting can also be used to set the running command channel.

Current running command channel P00.01	Multi-function terminal 36 Switch to keypad	Multi-function terminal 37 Switch to terminal	Multi-function terminal 38 Switch to communication
Keypad running command channel	/	Terminal running command channel	Communication running command channel
Terminal running command channel	Keypad running command channel	/	Communication running command channel
Communication running command channel	Keypad running command channel	Terminal running command channel	/

Note: “/” means the multi-function terminal is invalid on the current given channel.

Relative parameters table:

Function code	Name	Detailed instruction of parameters	Default value
P00.00	Speed control mode	0: Sensorless vector control mode 0 (apply to AM and SM) 1: Sensorless vector control mode 1 (applying to AM) 2: SVPWM control	1
P00.01	Run command channel	0: Keypad running command 1: Terminal running command channel (“LOCAL/REMOT” flickering) 2: Communication running command channel (“LOCAL/REMOT” on);	0
P00.02	Communication running commands	0: MODBUS communication channel 1: PROFIBUS\CANopen communication channel 2: Ethernet communication channel 3: Reserved	0
P00.18	Function restore parameter	0: No operation 1: Restore the default value 2: Cancel the fault record	0
P00.15	Motor parameter autotuning	0: No operation 1: Rotating autotuning 2: Static autotuning 1 (autotune totally) 3: Static autotuning 2 (autotune part of the parameters)	0
P02.00	Motor type 1	0: Asynchronous motor 1: Synchronous motor	0

Function code	Name	Detailed instruction of parameters	Default value
P02.01	Rated power of asynchronous motor 1	0.75–110kW (1–150HP)	Depend on model
P02.02	Rated frequency of asynchronous motor 1	0.01Hz–P00.03 (the max frequency)	60.00Hz
P02.03	Rated speed of asynchronous motor 1	1–36000rpm	Depend on model
P02.04	Rated voltage of asynchronous motor 1	0–1200V	Depend on model
P02.05	Rated current of asynchronous motor 1	0.8–6000.0A	Depend on model
P02.15	Rated power of synchronous motor 1	0.75–110kW (1–150HP)	Depend on model
P02.16	Rated frequency of synchronous motor 1	0.01Hz–P00.03 (the max frequency)	60.00Hz
P02.17	Number of poles pairs for synchronous motor 1	1–50	2
P02.18	Rated voltage of synchronous motor 1	0–1200V	Depend on model
P02.19	Rated current of synchronous motor 1	0.8–6000.0A	Depend on model
P05.01–P05.09	Multi-function digital input terminals (S1–S8, HDI) function selection	36: Shift the command to keypad 37: Shift the command to terminals 38: Shift the command to communication	
P07.01	Parameter copy	The function code determines the manner of parameters copy. 0: No operation 1: Upload the local function parameter to the keypad 2: Download the keypad function parameter to local address (including the motor parameters) 3: Download the keypad function parameter to local address (excluding the motor parameter of P02 and P12 group) 4: Download the keypad function parameters to local address (only for the motor parameter of P02 and P12 group)	0

Function code	Name	Detailed instruction of parameters	Default value
P07.02	<div style="border: 1px solid black; display: inline-block; padding: 2px;">QUICK/JOG</div> function selection	0: No function 1: Jogging 2: Shift the display state by the shifting key 3: Shift between forward rotations and reverse rotations 4: Clear UP/DOWN settings 5: Coast to stop 6: Shift the given manner of running commands 7: Quick commissioning mode (committee according to the non-factory parameter)	1

7.3 Vector control

Because asynchronous motors have the characteristics of high stage, nonlinear, strong coupling and various variables, the actual control of the asynchronous motor is very difficult. Vector control is mainly used to settle this problem with the theme of that divide the stator current vector into exciting current (the current heft generating internal magnetic field of the motor) and torque current (the current heft generating torque) by controlling and measuring the stator current vector according to the principles of beamed magnetic field to control the range and phase of these two hefts. This method can realize the decoupling of exciting current and torque current to adjust the high performance of asynchronous motors.

UMI-B5 UL series inverters are embedded with speed sensor-less vector control calculation for driving both asynchronous motors and synchronous motors. Because the core calculation of vector control is based on exact motor parameter models, the accuracy of motor parameter will impact on the performance of vector control. It is recommended to input the motor parameters and carry out autotune before vector running.

Because the vector control calculation is very complicated, high technical theory is needed for the user during internal autotune. It is recommended to use the specific function parameters in vector control with cautions.

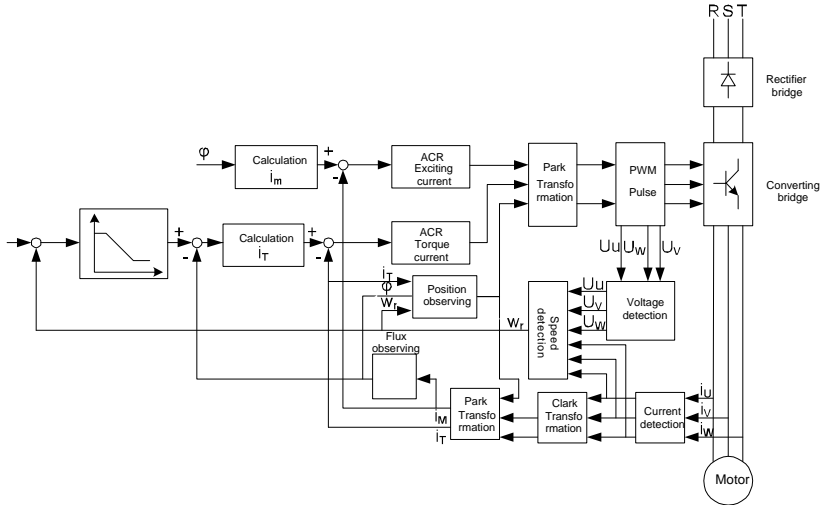

Function code	Name	Detailed instruction of parameters	Default value
P00.00	Speed control mode	0: Sensorless vector control mode 0 (apply to AM and SM) 1: Sensorless vector control mode 1 (applying to AM) 2: SVPWM control	1
P00.15	Motor parameter autotuning	0: No operation 1: Rotating autotuning 2: Static autotuning 1 (autotune totally) 3: Static autotuning 2 (autotune part of the parameters)	0
P02.00	Motor type 1	0: Asynchronous motor 1: Synchronous motor	0
P03.00	Speed loop proportional gain1	0–200.0	20.0
P03.01	Speed loop integral time1	0.000–10.000s	0.200s
P03.02	Low switching frequency	0.00Hz–P03.05	5.00Hz
P03.03	Speed loop proportional gain 2	0–200.0	20.0
P03.04	Speed loop integral time 2	0.000–10.000s	0.200s
P03.05	High switching	P03.02–P00.03 (the max frequency)	10.00Hz

Function code	Name	Detailed instruction of parameters	Default value
	frequency		
P03.06	Speed loop output filter	0–8 (corresponds to 0–2 ⁸ /10ms)	0
P03.07	Compensation coefficient of electromotion slip	50%–200%	100%
P03.08	Compensation coefficient of braking slip	50%–200%	100%
P03.09	Current loop percentage coefficient P	0–65535	1000
P03.10	Current loop integral coefficient 1	0–65535	1000
P03.11	Torque setting method	This parameter is used to enable the torque control mode, and set the torque. 0: Torque control is invalid 1: Keypad setting torque (P03.12) 2: Analog AI1 setting torque 3: Analog AI2 setting torque 4: Analog AI3 setting torque 5: Pulse frequency HDI setting torque 6: Multi-step torque setting 7: MODBUS communication setting torque 8: PROFIBUS/CANopen communication setting torque 9: Ethernet communication setting torque 10: Reserved	0
P03.12	Keypad setting torque	-300.0%–300.0% (rated motor current)	50.0%
P03.13	Torque reference filter time	0.000–10.000s	0.010s
P03.14	Upper frequency of forward rotation in vector control	0: Keypad (P03.16 sets P03.14, P03.17 sets P03.15) 1: AI1	0
P03.15	Upper frequency of reverse rotation in vector control	2: AI2 3: AI3 4: Pulse frequency HDI setting upper-limit frequency 5: Multi-step setting upper-limit frequency 6: MODBUS communication setting upper-limit frequency 7: PROFIBUS/CANopen communication	0

Function code	Name	Detailed instruction of parameters	Default value
		setting upper-limit frequency 8: Ethernet communication setting upper-limit frequency 9: Reserved	
P03.16	Keypad setting for upper frequency of forward rotation	Setting range: 0.00Hz–P00.03 (the max frequency)	60.00Hz
P03.17	Keypad setting for upper frequency of reverse rotation		60.00Hz
P03.18	Upper electromotion torque source	0: Keypad setting upper-limit frequency (P03.20 sets P03.18, P03.21 sets P03.19)	0
P03.19	Upper braking torque source	1: AI1 2: AI2 3: AI3 4: HDI 5: MODBUS communication 6: PROFIBUS/CANopen communication 7: Ethernet communication 8: Reserved	0
P03.20	Keypad setting of electromotion torque	0.0–300.0% (rated current of the motor)	180.0%
P03.21	Keypad setting of braking torque		180.0%
P03.22	Flux weakening coefficient in constant power zone	0.1–2.0	0.3
P03.23	Lowest flux weakening point in constant power zone	10%–100%	20%
P03.24	Max. voltage limit	0.0–120.0%	100.0%
P03.25	Pre-exciting time	0.000–10.000s	0.300s
P17.32	Magnetic flux linkage	0.0–200.0%	0

7.4 SVPWM control

UMI-B5 UL series inverters provide internal SVPWM control which can be used in the cases where it does not need high control accuracy. It is also recommended to use SVPWM control when one inverter drives multiple motors.

UMI-B5 UL series inverters provide multiple V/F curve modes. The user can select the corresponding V/F curve according to the site needs. Or they can set the corresponding V/F curve based on their own needs.

Recommendations:

For the load of constant torque, such as the conveyor belt which runs linearly, it is proper to select linear V/F curve because it needs constant torque.

For the load of decreasing torque, such as fans and water pumps, it is proper to select corresponding 1.3th, 1.7th or 2th power of V/F curve because the actual torque is 2-squared or 3-squared of the rotating speed.

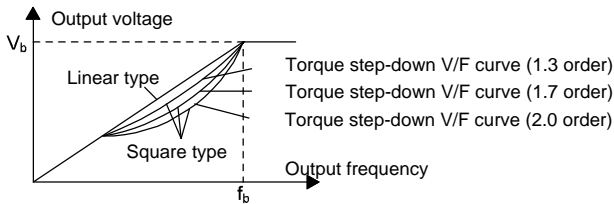

UMI-B5 UL series inverters provide multi-dots V/F curve, the user can change the output V/F curve by setting the voltage and frequency of three middle dots. The whole curve consists of 5 dots. The starting dot is (0Hz, 0V), and the ending dot is (the basic frequency of the motor, the rated voltage of the motor). During the setting processing: $0 \leq f_1 \leq f_2 \leq f_3 \leq$ the basic frequency of the motor; $0 \leq V_1 \leq V_2 \leq V_3 \leq$ the rated voltage of the motor.

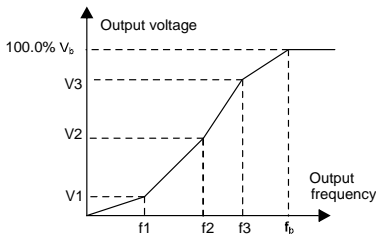

UMI-B5 UL series inverters provide special function code for SVPWM control mode which can improve the performance of SVPWM control by means of setting.

1. Torque boost

Torque boost function can compensate the performance of low speed torque during SVPWM control. The inverter will adjust the torque boost according to the actual load.

Note:

The torque boost takes effect only when the frequency is under the cap frequency of the boost.

If the torque boost is too big, low frequency vibration or overcurrent fault may occur. Lower the torque boost.

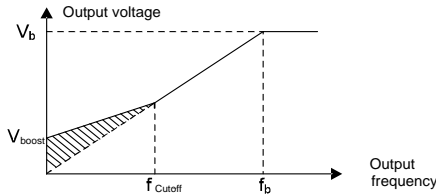
**2. Energy-saving running**

In the actual operation, the inverter can search by itself to achieve a better effect point. The inverter can work with high effect to save energy.

Note:

This function is usually used in the cases where the load is light or empty.

If the load transients frequently, this function is not appropriate to be selected.

3. V/F slips compensation gain

SVPWM control belongs to the open loop mode. If the load of the motor transients suddenly, the fluctuation of the rotation speed may occur. In the cases where the high accuracy speed is needed, slip compensation gain (internal output adjustment) can be set to compensate the speed change caused by load fluctuation.

Setting range of slip compensation gain: 0–200%, of which 100% corresponds to the rated slip frequency.

Note: Rated slip frequency= (rated synchronous rotation speed of the motor-rated rotation speed of the motor) *number of pole pairs/60.

4. Vibration control

Motor vibration occurs frequently when applying SVPWM control mode in the cases where high power is needed. In order to settle this problem, UMI-B5 UL series inverters add two function codes which are set to control the vibration factors. The user can set the corresponding function code according to the vibration frequency.

Note: Bigger the set value, more effective is the control. If the set value is too big, overcurrent may occur to the motor.

5. User-defined V/F curve (V/F separation) function

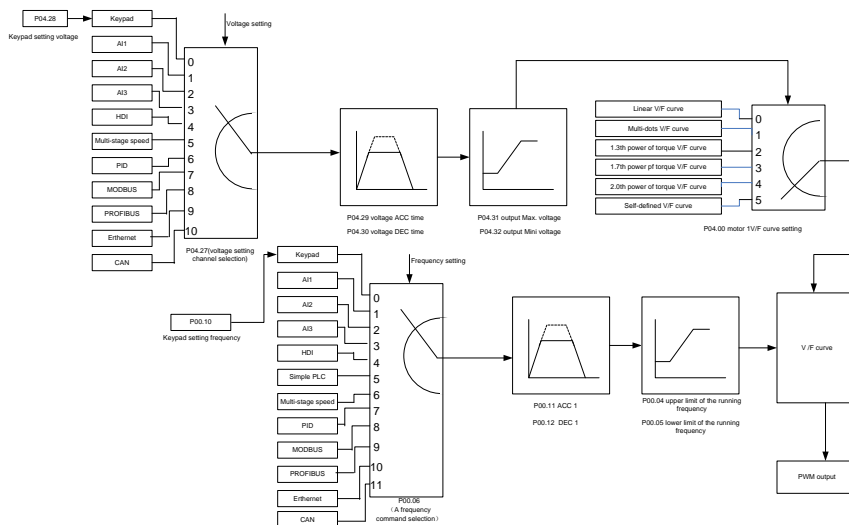

When the user selects the user-defined V/F curve function in UMI-B5 UL series inverters, they can set the given channel of voltage and frequency and the corresponding ACC/DEC time, or the two can combine to form a real-time curve.

Note: the application of V/F curve separation can be used in many cases with various kinds of power supply of the inverter. But the users should set and adjust the parameters with caution. Incorrect parameters may cause damage to the inverter.

Function code	Name	Detailed instruction of parameters	Default value
P00.00	Speed control mode	0: Sensorless vector control mode 0 (apply to AM and SM) 1: Sensorless vector control mode 1 (applying to AM) 2: SVPWM control	1
P00.03	Max. output frequency	P00.04–400.00Hz	60.00Hz
P00.04	Upper limit of the running frequency	P00.05–P00.03	60.00Hz
P00.05	Lower limit of the running frequency	0.00Hz–P00.04	0.00Hz
P00.11	ACC time 1	0.0–3600.0s	Depend on model
P00.12	DEC time 1	0.0–3600.0s	Depend on model

Function code	Name	Detailed instruction of parameters	Default value
P02.00	Motor type 1	0: Asynchronous motor 1: Synchronous motor	0
P02.02	Rated frequency of asynchronous motor 1	0.01Hz–P00.03 (max frequency)	60.00
P02.04	Rated voltage of asynchronous motor 1	0–1200V	Depend on model
P04.00	Motor 1V/F curve setting	0: Straight line V/F curve; applying to the constant torque load 1: Multi-dots V/F curve 2: 1.3 th power low torque V/F curve 3: 1.7 th power low torque V/F curve 4: 2.0 th power low torque V/F curve 5: Customized V/F (V/F separation)	0
P04.01	Torque boost of motor 1	0.0%: (automatic)0.1%–10.0%	0.0%
P04.02	Torque boost close of motor 1	0.0%–50.0% (rated frequency of motor 1)	20.0%
P04.03	V/F frequency 1 of motor 1	0.00Hz–P04.05	0.00Hz
P04.04	V/F voltage 1 of motor 1	0.0%–110.0%	0.0%
P04.05	V/F frequency 2 of motor 1	P04.03– P04.07	00.00Hz
P04.06	V/F voltage 2 of motor 1	0.0%–110.0%	0.0%
P04.07	V/F frequency 3 of motor 1	P04.05–P02.02 or P04.05–P02.16	00.00Hz
P04.08	V/F voltage 3 of motor 1	0.0%–110.0%	0.0%
P04.09	V/F slip compensation gain of motor 1	0.0–200.0%	100.0%
P04.10	Vibration control factor at low frequency of motor 1	0–100	10
P04.11	Vibration control factor at high frequency of motor 1	0–100	10
P04.12	Vibration control threshold of motor 1	0.00Hz–P00.03 (the max frequency)	30.00 Hz
P04.13	Motor 2 V/F curve setting	0: Straight line V/F curve; applying to the constant torque load 1: Multi-dots V/F curve 2: Torque step-down V/F curve (1.3 order) 3: Torque step-down V/F curve (1.7 order) 4: Torque step-down V/F curve (2.0 order) 5: Customized V/F (V/F separation)	0
P04.14	Torque boost of motor 2	0.0%: (automatic) 0.1%–10.0%	0.0%

Function code	Name	Detailed instruction of parameters	Default value
P04.15	Torque boost close of motor 2	0.0%–50.0% (rated frequency of motor 1)	20.0%
P04.16	V/F frequency 1 of motor 2	0.00Hz–P04.05	0.00Hz
P04.17	V/F voltage 1 of motor 2	0.0%–110.0%	0.0%
P04.18	V/F frequency 2 of motor 2	P04.16– P04.20	0.00Hz
P04.19	V/F voltage 2 of motor 2	0.0%–110.0%	0.0%
P04.20	V/F frequency 3 of motor 2	P04.18– P02.02 or P04.18– P02.16	0.00Hz
P04.21	V/F voltage 3 of motor 2	0.0%–110.0%	0.0%
P04.22	V/F slip compensation gain of motor 2	0.0–200.0%	100.0%
P04.23	Vibration control factor at low frequency of motor 2	0–100	10
P04.24	Vibration control factor at high frequency of motor 2	0–100	10
P04.25	Vibration control threshold of motor 2	0.00Hz–P00.03 (the max frequency)	30.00Hz
P04.26	Energy-saving operation	0: No action 1: Automatic energy-saving running	0
P04.27	Voltage setting	0: Keypad: the output voltage is determined by P04.28. 1: AI1 ; 2: AI2; 3: AI3; 4: HDI; 5: Multi-step speed; 6: PID; 7: MODBUS communication; 8: PROFIBUS/CANopen communication; 9: Ethernet communication; 10: Reserved	0
P04.28	Keypad setting voltage	0.0%–100.0% (rated motor voltage)	100.0%
P04.29	Voltage increasing time	0.0–3600.0s	5.0s
P04.30	Voltage decreasing time	0.0–3600.0s	5.0s
P04.31	Maximum output voltage	P04.32–100.0% (rated motor voltage)	100.0%
P04.32	Minimum output voltage	0.0%–P04.31 (rated motor voltage)	0.0%

7.5 Torque control

UMI-B5 UL series inverters support two kinds of control mode: torque control and rotation speed control. The core of rotation speed is that the whole control focuses on the stable speed and ensures

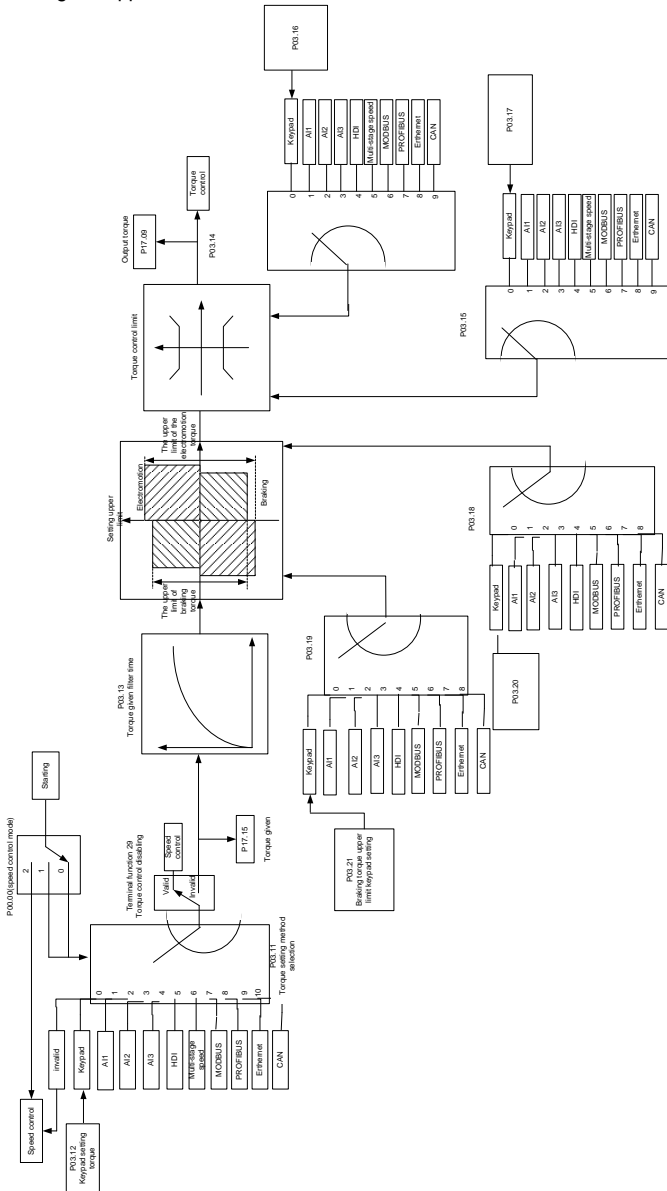

the setting speed is the same as the actual running speed. The max load should be in the range of the torque limit. The core of torque control is that the whole control focuses on the stable torque and ensures the setting torque is the same as the actual output torque. At the same time, the output frequency is among the upper limit or the lower limit.



Function code	Name	Detailed instruction of parameters	Default value
P00.00	Speed control mode	0: Sensorless vector control mode 0 (apply to AM and SM) 1: Sensorless vector control mode 1 (applying to AM) 2: SVPWM control	1
P03.11	Torque setting method	0: Torque control is invalid 1: Keypad setting torque (P03.12) 2: Analog AI1 setting torque 3: Analog AI2 setting torque 4: Analog AI3 setting torque 5: Pulse frequency HDI setting torque 6: Multi-step torque setting 7: MODBUS communication setting torque 8: PROFIBUS\CANopen communication setting torque 9: Ethernet communication setting torque 10: Reserved	0
P03.12	Keypad setting torque	-300.0%~300.0% (rated motor current)	50.0%
P03.13	Torque reference filter time	0.000~10.000s	0.010s
P03.14	Upper frequency of forward rotation in vector control	0: Keypad (P03.16 sets P03.14, P03.17 sets P03.15) 1: AI1	0
P03.15	Upper frequency of reverse rotation in vector control	2: AI2 3: AI3 4: Pulse frequency HDI setting upper-limit frequency 5: Multi-step setting upper-limit frequency 6: MODBUS communication setting upper-limit frequency 7: PROFIBUS/CANopen communication setting upper-limit frequency 8: Ethernet communication setting upper-limit frequency 9: Reserved	0
P03.16	Keypad setting for upper frequency of forward rotation	0.00Hz~P00.03 (the max frequency)	60.00 Hz

Function code	Name	Detailed instruction of parameters	Default value
P03.17	Keypad setting for upper frequency of reverse rotation	0.00 Hz–P00.03 (the max frequency)	60.00 Hz
P03.18	Upper electromotion torque source	0: Keypad setting upper-limit frequency (P03.20 sets P03.18, P03.21 sets P03.19)	0
P03.19	Upper braking torque source	1: AI1 2: AI2 3: AI3 4: HDI 5: MODBUS communication 6: PROFIBUS/CANopen communication 7: Ethernet communication 8: Reserved	0
P03.20	Keypad setting of electromotion torque	0.0–300.0% (rated motor current)	180.0%
P03.21	Keypad setting of braking torque	0.0–300.0% (rated motor current)	180.0%
P17.09	Output torque	-250.0–250.0%	0.0%
P17.15	Torque reference	-300.0–300.0% (rated current of the motor)	0.0%

7.6 Parameters of the motor

	<ul style="list-style-type: none"> ◇ Physical accident may occur if the motor starts up suddenly during autotune. Check the safety of surrounding environment of the motor and the load before autotune. ◇ The power is still applied even the motor stops running during static autotune. Do not touch the motor until the autotune is completed, otherwise there would be electric shock.
	<ul style="list-style-type: none"> ◇ Do not carry out the rotation autotune if the motor is coupled with the load, do not operate on the rotation autotune. Otherwise, misacts or damage may occur to the inverter or the mechanical devices. When carry out autotune on the motor which is coupled with load, the motor parameter won't be counted correctly and misacts may occur. It is proper to de-couple the motor from the load during autotune when necessary.

UMI-B5 UL series inverters can drive both asynchronous motors and synchronous motors. And at the same time, they can support two sets of motor parameters which can shift between two motors through multi-function digital input terminal or communication.

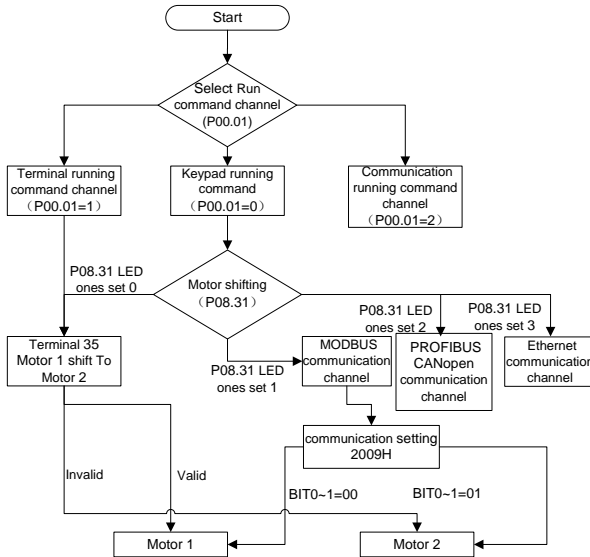

The control performance of the inverter is based on the established accurate motor model. The user has to carry out the motor autotune before first running (take motor 1 as the example).

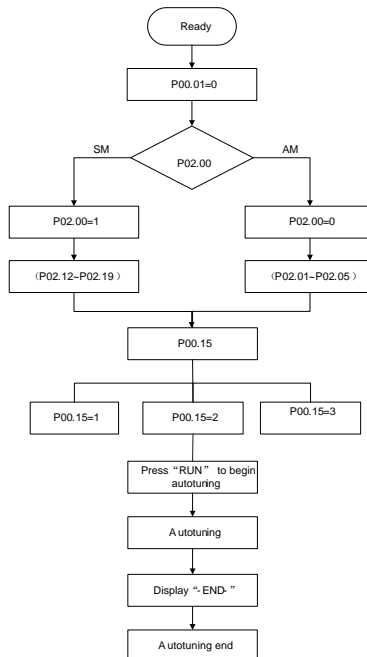

Note:

1. Set the motor parameters according to the name plate of the motor.
2. During the motor autotune, de-couple the motor from the load if rotation autotune is selected to make the motor is in a static and empty state, otherwise the result of autotune is incorrect. The asynchronous motors can autotune the parameters of P02.06–P02.10, while the synchronous motors can autotune the parameters of P02.20–P02.23.
3. During the motor autotune, do not to de-couple the motor from the load if static autotune is selected. Because only some parameters of the motor are involved, the control performance is not as better as the rotation autotune. The asynchronous motors can autotune the parameters of P02.06–P02.10, while the synchronous motors can autotune the parameters of P02.20–P02.22. P02.23 (synchronous motor 1 counter-electromotive force constant) can be counted to attain.
4. Motor autotune only involves the current motor. Switch the motor through P08.31 to carry out the autotune on the other motor.

Related parameters list:

Function code	Name	Detailed instruction of parameters	Default value
P00.01	Run command channel	0: Keypad running command 1: Terminal running command channel ("LOCAL/REMOT" flickering) 2: Communication running command channel ("LOCAL/REMOT" on);	0
P00.15	Motor parameter autotuning	0: No operation 1: Rotating autotuning 2: Static autotuning 1 (autotune totally) 3: Static autotuning 2 (autotune part parameters)	0
P02.00	Motor type 1	0: Asynchronous motor 1: Synchronous motor	0
P02.01	Rated power of AM 1	0.75–110kW (1–150HP)	Depend on model
P02.02	Rated frequency of AM 1	0.01Hz–P00.03 (the max frequency)	60.00Hz
P02.03	Rated speed of AM 1	1–36000rpm	Depend on model
P02.04	Rated voltage of AM 1	0–1200V	Depend on model
P02.05	Rated current of AM 1	0.8–6000.0A	Depend on model
P02.06	Stator resistor of AM 1	0.001–65.535Ω	Depend on model
P02.07	Rotor resistor of AM 1	0.001–65.535Ω	Depend on model
P02.08	Leakage inductance of AM 1	0.1–6553.5mH	Depend on model
P02.09	Mutual inductance of AM 1	0.1–6553.5mH	Depend on model

Function code	Name	Detailed instruction of parameters	Default value
P02.10	Non-load current of AM1	0.1–6553.5A	Depend on model
P02.15	Rated power of SM 1	0.75–110kW (1–150HP)	Depend on model
P02.16	Rated frequency of SM 1	0.01Hz–P00.03 (the max frequency)	60.00Hz
P02.17	Number of poles pairs for SM 1	1–50	2
P02.18	Rated voltage of SM 1	0–1200V	Depend on model
P02.19	Rated current of SM 1	0.8–6000.0A	Depend on model
P02.20	Stator resistor of SM 1	0.001–65.535Ω	Depend on model
P02.21	Direct axis inductance of SM 1	0.01–655.35mH	Depend on model
P02.22	Quadrature axis inductance of SM 1	0.01–655.35mH	Depend on model
P02.23	Back EMF constant of SM 1	0–10000	300
P05.01–P05.09	Multi-function digital input terminals (S1–S8, HDI) function selection	35: Shift from motor 1 to motor 2	
P08.31	Motor shifting	LED ones: shifting channel 0: terminal shifting 1: MODBUS communication shifting 2: PROFIBUS/CANopen communication shifting 3: Ethernet communication shifting 4: Reserved LED tens: shifting enabling in operation 0: Disabled 1: Enabled 0x00–0x14	00
P12.00	Motor type 2	0: Asynchronous motor 1: Synchronous motor	0
P12.01	Rated power of AM 2	0.75–110kW (1–150HP)	Depend on model
P12.02	Rated frequency of AM 2	0.01Hz–P00.03 (the max frequency)	60.00Hz
P12.03	Rated speed of AM 2	1–36000rpm	Depend on model
P12.04	Rated voltage of AM 2	0–1200V	Depend on model
P12.05	Rated current of AM 2	0.8–6000.0A	Depend on model
P12.06	Stator resistor of AM 2	0.001–65.535Ω	Depend on model
P12.07	Rotor resistor of AM 2	0.001–65.535Ω	Depend on model
P12.08	Leakage inductance of AM 2	0.1–6553.5mH	Depend on model

Function code	Name	Detailed instruction of parameters	Default value
P12.09	Mutual inductance of AM 2	0.1–6553.5mH	Depend on model
P12.10	Non-load current of AM 2	0.1–6553.5A	Depend on model
P12.15	Rated power of SM 2	0.75–110kW (1–150HP)	Depend on model
P12.16	Rated frequency of SM 2	0.01Hz–P00.03 (the max frequency)	60.00Hz
P12.17	Number of poles pairs for SM 2	1–50	2
P12.18	Rated voltage of SM 2	0–1200V	Depend on model
P12.19	Rated current of SM 2	0.8–6000.0A	Depend on model
P12.20	Stator resistor of SM 2	0.001–65.535 Ω	Depend on model
P12.21	Direct axis inductance of SM 2	0.01–655.35mH	Depend on model
P12.22	Quadrature axis inductance of SM 2	0.01–655.35mH	Depend on model
P12.23	Back EMF constant of SM 2	0–10000	300

7.7 Start-up and stop control

The start-up and stop control of the inverter includes three states: start after the running command during normal powering on, start after the restarting function becomes valid during normal powering on and start after the automatic fault reset. Below is the detailed instruction for three startings.

There are three starting methods for the inverter: start from the starting frequency directly, start after the AC braking and start after the rotation speed tracking. The user can select according to different situations to meet their needs.

For the load with big inertia, especially in the cases where the reverse rotation may occur, it is better to select starting after DC braking and then starting after rotation speed tracking.

Note: it is recommended to use the direct starting to drive synchronous motor.

1. The starting logic figure of starting after the running command during the normal powering on

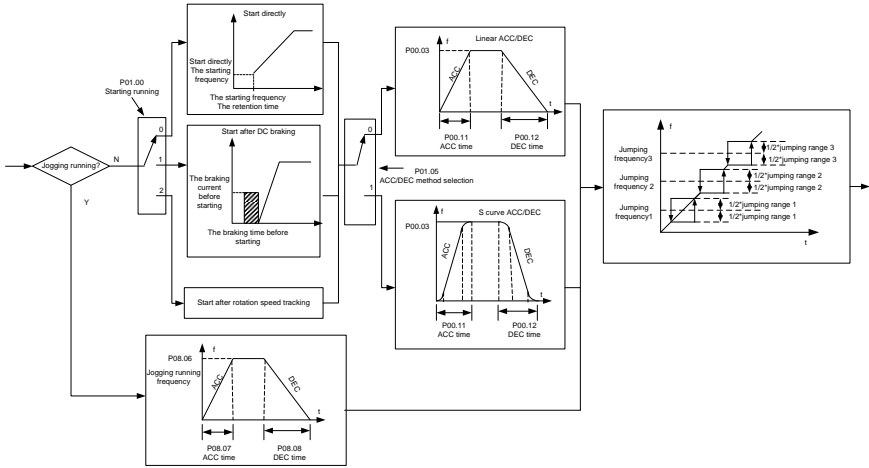

2. The starting logic figure of starting after the restarting function becomes valid during the normal powering on

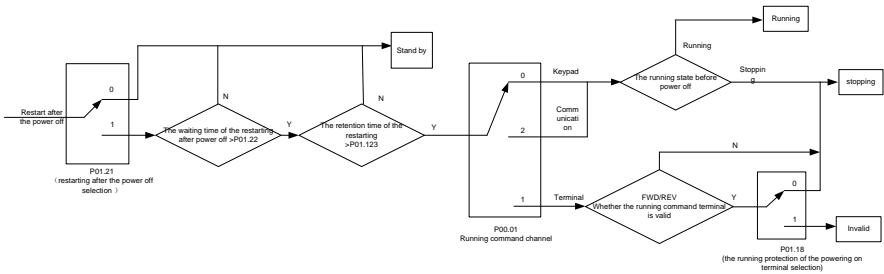

3. The starting logic figure of starting after the automatic fault reset

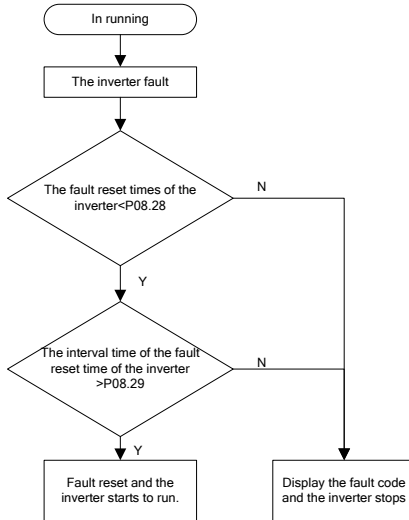

Related parameters list:

Function code	Name	Detailed instruction of parameters	Default value
P00.01	Run command channel	0: Keypad running command 1: Terminal running command channel ("LOCAL/REMOTE" flickering) 2: Communication running command channel ("LOCAL/REMOTE" on);	0
P00.11	ACC time 1	0.0–3600.0s	Depend on model
P00.12	DEC time 1	0.0–3600.0s	Depend on model
P01.00	Start mode	0: Start-up directly 1: Start-up after DC braking 2: Start-up after rotation speed tracking 1	0
P01.01	Starting frequency of direct start	0.00–50.00Hz	0.50Hz
P01.02	Retention time of the starting frequency	0.0–50.0s	0.0s
P01.03	The braking current before starting	0.0–100.0%	0.0%
P01.04	The braking time before starting	0.00–50.00s	0.00s
P01.05	ACC/DEC selection	0: Linear type	0

Function code	Name	Detailed instruction of parameters	Default value
		1: Reserved	
P01.08	Stop mode	0: Decelerate to stop 1: Coast to stop	0
P01.09	Starting frequency of DC braking	0.00Hz–P00.03 (the max frequency)	0.00Hz
P01.10	Waiting time of DC braking	0.00–50.00s	0.00s
P01.11	DC braking current	0.0–100.0%	0.0%
P01.12	DC braking time	0.00–50.00s	0.00s
P01.13	Dead time of FWD/REV rotation	0.0–3600.0s	0.0s
P01.14	Shifting between FWD/REV rotation	Set the threshold point of the inverter: 0: Switch after 0 frequency 1: Switch after the starting frequency 2: Switch after the speed reach P01.15 and delay for P01.24	0
P01.15	Stopping speed	0.00–100.00Hz	0.50 Hz
P01.16	Detection of stopping speed	0: Speed setting (the only detection method in SVPWM mode) 1: Speed detecting value	1
P01.18	Terminal running protection when powering on	0: The terminal running command is invalid when powering on 1: The terminal running command is valid when powering on	0
P01.19	Action if running frequency < lower limit frequency (valid >0)	0: Run at the lower-limit frequency 1: Stop 2: Hibernation	0
P01.20	Hibernation restore delay time	0.0–3600.0s (valid when P01.19=2)	0.0s
P01.21	Restart after power off	0: Disable 1: Enable	0
P01.22	The waiting time of restart after power off	0.0–3600.0s (valid when P01.21=1)	1.0s
P01.23	Start delay time	0.0–60.0s	0.0s
P05.01–P05.09	Digital input function selection	1: Forward rotation operation 2: Reverse rotation operation 4: Forward rotation jogging 5: Reverse rotation jogging 6: Coast to stop	

Function code	Name	Detailed instruction of parameters	Default value
		7: Fault reset 8: Operation pause 21: ACC/DEC time option 1 22: ACC/DEC time option 2 30: ACC/DEC prohibition	
P08.06	Jogging frequency	0.00Hz–P00.03 (the max frequency)	5.00Hz
P08.07	Jogging ACC time	0.0–3600.0s	Depend on model
P08.08	Jogging DEC time	0.0–3600.0s	Depend on model
P08.00	ACC time 2	0.0–3600.0s	Depend on model
P08.01	DEC time 2	0.0–3600.0s	Depend on model
P08.02	ACC time 3	0.0–3600.0s	Depend on model
P08.03	DEC time 3	0.0–3600.0s	Depend on model
P08.04	ACC time 4	0.0–3600.0s	Depend on model
P08.05	DEC time 4	0.0–3600.0s	Depend on model
P08.28	Fault reset times	0–10	0
P08.29	Interval time of automatic fault reset	0.1–3600.0s	1.0s

7.8 Frequency setting

UMI-B5 UL series inverters can set the frequency by various means. The given channel can be divided into main given channel and assistant given channel.

There are two main given channels: A frequency given channel and B frequency given channel. These two given channels can carry out mutual simple math calculation between each other. And the given channels can be shifted dynamically through set multi-function terminals.

There are three assistant given channels: keypad UP/DOWN input, terminals UP/DOWN switch input and digital potentiometer input. The three ways equal to the effect of input UP/DOWN given in internal assistant given of the inverter. The user can enable the given method and the effect of the method to the frequency given by setting function codes.

The actual given of the inverter consists of main given channel and assistant given channel.

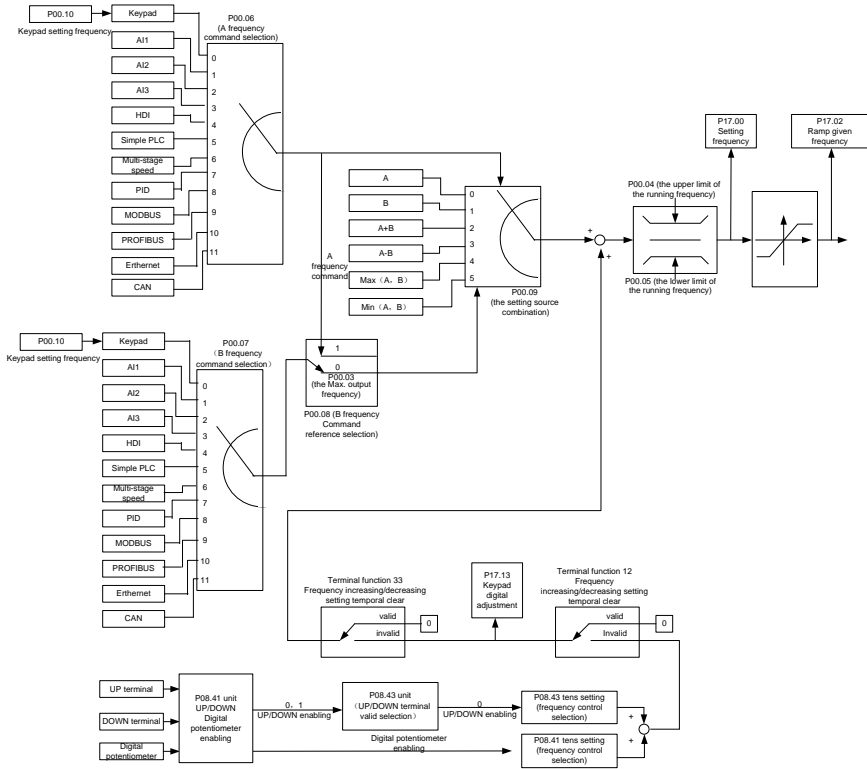

UMI-B5 UL series inverters support the shifting between different given channels, and the detailed shifting rules is as below:

Current given channel P00.09	Multi-function terminal function 13 Switch from A channel to B channel	Multi-function terminal function 14 Switch from combination setting to A channel	Multi-function terminal function 15 Switch from combination setting to B channel
A	B	/	/
B	A	/	/
A+B	/	A	B
A-B	/	A	B
Max (A, B)	/	A	B
Min (A, B)	/	A	B

Note: "/" means the multi-function terminal is invalid under the current given channel.

When selecting multi-function terminal UP (10) and DOWN (11) to set the internal assistant frequency, P08.44 and P08.45 can be set to increase or decrease the set frequency quickly.

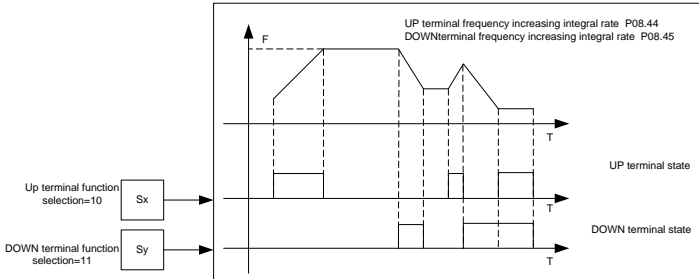

Related parameters list:

Function code	Name	Detailed instruction of parameters	Default value
P00.03	Max. output frequency	P00.04–400.00Hz	60.00Hz
P00.04	Upper limit of the running frequency	P00.05–P00.03	60.00Hz
P00.05	Lower limit of the running frequency	0.00Hz–P00.04	0.00Hz
P00.06	A frequency command	0: Keypad	0
P00.07	B frequency command	1: AI1 2: AI2 3: AI3 4: High-speed pulse HDI setting 5: Simple PLC program setting 6: Multi-step speed running setting 7: PID control setting 8: MODBUS communication setting 9: PROFIBUS/CANopen communication setting 10: Ethernet communication setting (reserved) 11: Reserved	0
P00.08	B frequency command reference	0: Maximum output frequency 1: A frequency command	0
P00.09	Combination of the setting source	0: A 1: B 2: (A+B) combination 3: (A-B) combination 4: Max (A, B) combination 5: Min (A, B) combination	0

Function code	Name	Detailed instruction of parameters	Default value
P05.01–P05.09	Multi-function digital input terminals (S1–S8, HDI) function selection	10: Increasing frequency setting (UP) 11: Decreasing frequency setting (DOWN) 12: Cancel the frequency change setting 13: Shift between A setting and B setting 14: Shift between combination setting and A setting 15: Shift between combination setting and B setting	
P08.42	Keypad data control	0x000–0x1223 LED ones: frequency enable selection 0: Both \wedge/\vee keys and digital potentiometer adjustments are valid 1: Only \wedge/\vee keys adjustment is valid 2: Only digital potentiometer adjustments is valid 3: Neither \wedge/\vee keys nor digital potentiometer adjustments are valid LED tens: frequency control selection 0: Only valid when P00.06=0 or P00.07=0 1: Valid for all frequency setting manner 2: Invalid for multi-step speed when multi-step speed has the priority LED hundreds: action selection during stopping 0: Setting is valid 1: Valid during running, cleared after stopping 2: Valid during running, cleared after receiving the stop command LED thousands: \wedge/\vee keys and digital potentiometer Integral function 0: The Integral function is valid 1: The Integral function is invalid	0x0000
P08.43	Integral ratio of the keypad potentiometer	0.01–10.00s	0.10s
P08.44	UP/DOWN terminals control	0x00–0x221 LED ones: frequency control selection 0: UP/DOWN terminals setting valid 1: UP/DOWN terminals setting valid LED tens: frequency control selection	0x000

Function code	Name	Detailed instruction of parameters	Default value
		0: Only valid when P00.06=0 or P00.07=0 1: All frequency means are valid 2: When the multi-step are priority, it is invalid to the multi-step LED hundreds: action selection when stop 0: Setting valid 1: Valid in the running, clear after stop 2: Valid in the running, clear after receiving the stop commands	
P08.45	UP terminals frequency changing ratio	0.01–50.00Hz/s	0.50 Hz/s
P08.46	DOWN terminals frequency changing ratio	0.01–50.00 Hz/s	0.50 Hz/s
P17.00	Setting frequency	Display current set frequency of the inverter Range: 0.00Hz–P00.03	0.00Hz
P17.02	Ramp reference frequency	Display current ramp given frequency of the inverter Range: 0.00Hz–P00.03	0.00Hz
P17.14	Digital adjustment	Display the adjustment through the keypad of the inverter. Range : 0.00Hz–P00.03	0.00V

7.9 Analog input

UMI-B5 UL series inverters have three analog input terminals and 1 high-speed pulse input terminals (of which, AI1 and AI2 are 0–10V/0–20mA and AI can select voltage input or current input by J3, AI2 can select voltage input or current input by J4 and AI3 is for -10–10V) as the standard configuration. The inputs can be filtered and the maximum and minimum values can be adjusted.

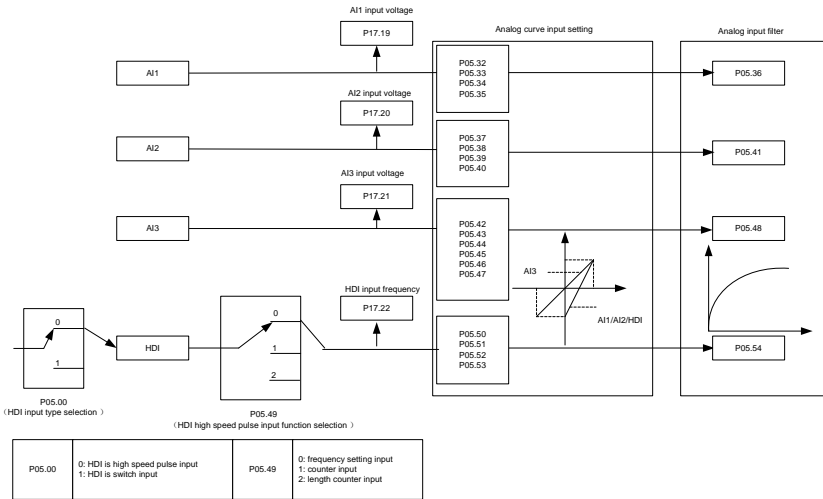

Related parameters list:

Function code	Name	Detailed instruction of parameters	Default value
P05.00	HDI input selection	0: High pulse input. 1: Digital input.	0
P05.32	Lower limit of AI1	0.00V–P05.34	0.00V
P05.33	Corresponding setting of the lower limit of AI1	-100.0%–100.0%	0.0%
P05.34	Upper limit of AI1	P05.32–10.00V	10.00V
P05.35	Corresponding setting of the upper limit of AI1	-100.0%–100.0%	100.0%
P05.36	AI1 input filter time	0.000s–10.000s	0.100s
P05.37	Lower limit of AI2	0.00V–P05.39	0.00V
P05.38	Corresponding setting of the lower limit of AI2	-100.0%–100.0%	0.0%
P05.39	Upper limit of AI2	P05.37–10.00V	10.00V
P05.40	Corresponding setting of the upper limit of AI2	-100.0%–100.0%	100.0%

Function code	Name	Detailed instruction of parameters	Default value
P05.41	AI2 input filter time	0.000s–10.000s	0.100s
P05.42	Lower limit of AI3	-10.00V–P05.44	-10.00V
P05.43	Corresponding setting of the lower limit of AI3	-100.0%–100.0%	-100.0%
P05.44	Middle value of AI3	P05.42–P05.46	0.00V
P05.45	Corresponding middle setting of AI3	-100.0%–100.0%	0.0%
P05.46	Upper limit of AI3	P05.44–10.00V	10.00V
P05.47	Corresponding setting of the upper limit of AI3	-100.0%–100.0%	100.0%
P05.48	AI3 input filter time	0.000s–10.000s	0.100s
P05.49	HDI high-speed pulse input function selection	0: Frequency setting input, frequency setting source 1: Counter input, high-speed pulse counter input terminals 2: Length counting input, length counter input terminals	0
P05.50	Lower limit frequency of HDI	0.000kHz–P05.52	0.000kHz
P05.51	Corresponding setting of HDI low frequency setting	-100.0%–100.0%	0.0%
P05.52	Upper limit frequency of HDI	P05.50–50.000kHz	50.000kHz
P05.53	Corresponding setting of upper limit frequency of HDI	-100.0%–100.0%	100.0%
P05.54	HDI frequency input filter time	0.000s–10.000s	0.100s

7.10 Analog output

UMI-B5 UL series inverters have 2 analog output terminals (0–10V or 0–20mA) and 1 high speed pulse output terminal. Analog output signal can be filtered and the maximum and minimum values can be adjusted. The analog output signals can be proportional to motor speed, output frequency, output current, motor torque, motor power, etc.

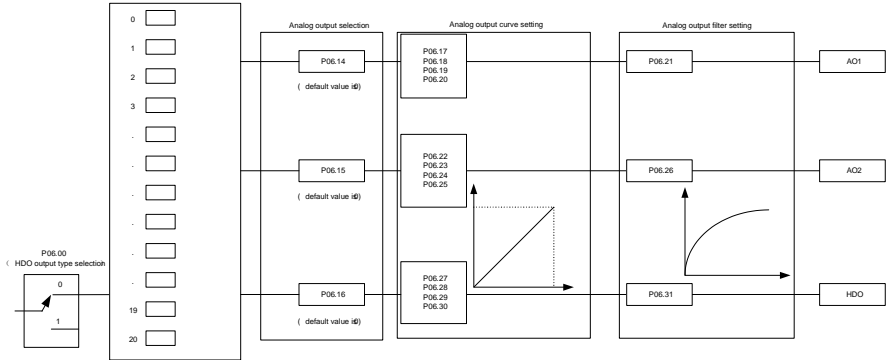

P06.00	0: open collector high speed pulse output
	1: open collector output

P06.01, P06.02, P06.03, P06.04 output selection					
0	Running frequency	1	Set frequency	2	Ramp given frequency
3	Running rotation speed	4	Output current (relative to the inverter)	5	Output current (relative to the motor)
6	Output voltage	7	Output power	8	Set torque
9	Output torque	10	Analog AI1 input value	11	Analog AI2 input value
12	Analog AI3 input value	13	HDI input value	14	MODBUS communication setting
15	MODBUS communication setting	16	PROFIBUS communication setting	17	PROFIBUS communication setting
18	Torque current (relative to the nominal current of the motor)	19	Exciting current (relative to the nominal current of the motor)	20	Reserved

Output instructions:

Set value	Function	Instructions
0	Running frequency	0–the max output frequency
1	Set frequency	0– the max output frequency
2	Ramp given frequency	0– the max output frequency
3	Running speed	0–2 times of the rated synchronous rotation speed of the motor
4	Output current (relative to the inverter)	0–2 times of the rated current of the inverter
5	Output current (relative to the motor)	0–2 times of the rated current of the inverter
6	Output voltage	0–1.5 times of the rated voltage of the inverter
7	Output power	0–2 times of the rated power
8	Setting torque value	0–2 times of the rated current of the motor
9	Output torque	0–2 times of the rated current of the motor

Set value	Function	Instructions
10	AI1	0–10V/0–20mA
11	AI2	0–10V/0–20mA
12	AI3	-10V–10V
13	HDI	0.00–50.00kHz
14	Setting value 1 of MODBUS communication	-1000–1000, 1000 corresponds to 100.0%
15	Setting value 2 of MODBUS communication	-1000–1000, 1000 corresponds to 100.0%
16	Setting value 1 of PROFIBUS/CANOPEN communication	-1000–1000, 1000 corresponds to 100.0%
17	Setting value 2 of PROFIBUS/CANOPEN communication	-1000–1000, 100 corresponds to 100.0%
18	Setting value 1 of Ethernet communication	-1000–1000, 1000 corresponds to 100.0%
19	Setting value 2 of Ethernet communication	-1000–1000, 100 corresponds to 100.0%
20–21	Reserved	
22	Torque current (relative to the rated current of the motor)	0–2 times of the rated current of the motor
23	Exciting current (relative to the rated current of the motor)	0–2 times of the rated current of the motor
24–30	Reserved	

Related parameters list:

Function code	Name	Detailed instruction of parameters	Default value
P06.00	HDO output	0: Open collector pole high speed pulse output 1: Open collector pole output.	0
P06.14	AO1 output	0: Running frequency	0
P06.15	AO2 output	1: Set frequency	0
P06.16	HDO high-speed pulse output	2: Ramp reference frequency 3: Running rotation speed 4: Output current (relative to the rated current of the inverter) 5: Output current (relative to the rated current of the motor) 6: Output voltage 7: Output power 8: Set torque value	0

Function code	Name	Detailed instruction of parameters	Default value
		9: Output torque 10: AI1 input value 11: AI2 input value 12: AI3 input value 13: High speed pulse HDI input value 14: MODBUS communication set value 1 15: MODBUS communication set value 2 16: PROFIBUS/CANopen communication set value 1 17: PROFIBUS/CANopen communication set value 2 18: Ethernet communication set value 1 19: Ethernet communication set value 2 20–21: Reserved 22: Torque current (relative to the rated current of the motor) 23: Pre-magnetizing current (relative to the rated current of the motor) 24–30: Reserved	
P06.17	Lower output limit of AO1	-100.0%–P06.19	0.0%
P06.18	Corresponding AO1 output of lower limit	0.00V–10.00V	0.00V
P06.19	Upper output limit of AO1	P06.17–100.0%	100.0%
P06.20	The corresponding AO1 output of upper limit	0.00V–10.00V	10.00V
P06.21	AO1 output filter time	0.000s–10.000s	0.000s
P06.22	Lower output limit of AO2	-100.0%–P06.24	0.0%
P06.23	Corresponding AO2 output of lower limit	0.00V–10.00V	0.00V
P06.24	Upper output limit of AO2	P06.22–100.0%	100.0%
P06.25	The corresponding AO2 output of upper limit	0.00V–10.00V	10.00V
P06.26	AO2 output filter time	0.000s–10.000s	0.000s
P06.27	Lower output limit of HDO	-100.0%–P06.29	0.00%
P06.28	Corresponding HDO output of lower limit	0.00–50.00kHz	0.0kHz
P06.29	Upper output limit of HDO	P06.27–100.0%	100.0%
P06.30	Corresponding HDO	0.00–50.00kHz	50.00kHz

Function code	Name	Detailed instruction of parameters	Default value
P06.31	HDO output filter time	0.000s–10.000s	0.000s

7.11 Digital input

UMI-B5 UL series inverters have 8 programmable digital input terminals and 1 open circuit electrode output terminal in the standard configuration. All functions of the digital input terminals are programmable by the function codes. Open collector pole input can be selected into high speed pulse input terminal or common switch input terminal by function code. When selected into HDI, the user can select HDI high speed pulse input as frequency given, counting input or length pulse input by setting.

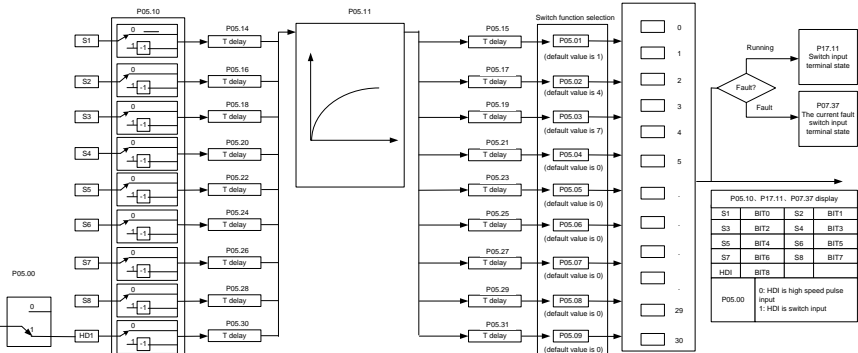

0	No function	1	Forward running	2	Reverse running	3	3-wire running control
4	Forward jugging	5	Reverse jugging	6	Coast to stop	7	Fault reset
8	Running pause	9	External fault input	10	Frequency setting increasing (UP)	11	Frequency setting decreasing (DOWN)
12	Frequency increasing/decreasing setting clear	13	Shifting between A frequency and B frequency	14	Shifting between the combination setting and A frequency	15	Shifting between the combination setting and B frequency
16	Multi-stage speed terminal 1	17	Multi-stage speed terminal 2	18	Multi-stage speed terminal 3	19	Multi-stage speed terminal 4
20	Multi-stage speed pause	21	ACC/DEC time selection 1	22	ACC/DEC time selection 2	23	Simple PLC stopping reset
23	Simple PLC pause	25	PID control pause	26	Traverse pause (stop at the current frequency)	27	Traverse reset (stop at the middle frequency)
28	Counter reset	29	Torque control disabling	30	ACC/DEC disabling	31	Counter triggering
32	Length reset	33	Frequency increasing/decreasing setting clear	34	DC braking	35	Shift from motor 1 to motor 2
36	Shift the command to the keypad	37	Shift the command to the terminal	38	Shift the command to the communication	39	Pre-exciting command
40	Power consumption clear	41	Power consumption keeping	42-43	Reserved		

This parameter is used to set the function corresponds to the digital multi-function terminals.

Note: two different multi-function terminals cannot be set as one function.

Set value	Function	Instructions
0	No function	The inverter does not work even there is input signal. It is necessary to set the terminal which cannot be used to non-function to avoid misacting.
1	Forward running (FWD)	The forward or reverse rotation of the inverter can be controlled by the external terminals.
2	Reverse running (REV)	

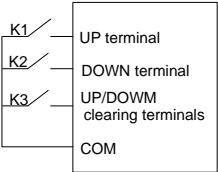
Set value	Function	Instructions
3	3-wire running control	The terminal can determine the running mode of the inverter is 3-wire control mode. Refer to P05.13 for detailed instruction of 3-wire control mode.
4	Forward jogging	See P08.06, P08.07 and P08.08 for jogging frequency, jogging ACC/DEC time.
5	Reverse jogging	
6	Coast to stop	The inverter closes off the output. The motor is not controlled by the inverter during the stopping. This method is usually to be used when the load inertia is big and it has no requirement to the stopping time. It has the same meaning with the “coast to stop” in P01.08 and usually used in remote control.
7	Fault reset	External fault reset. It has the same function with the reset function of STOP/RST on the keypad. This function can realize remote fault reset.
8	Operation pause	The inverter decelerates to stop. But all running parameters are in the memory state. For example, PLC parameters, traverse parameters and PID parameters. After the signal disappears, the inverter will come back to the state before stopping.
9	External fault input	When the external fault signal is sent to the inverter, the inverter will report the fault and stop.
10	Frequency setting up (UP)	This parameter is used to modify the increasing and decreasing command during the external terminal given frequency.
12	Frequency setting down (DOWN)	
12	Frequency increasing/decreasing setting clear	 <p>Frequency increasing/decreasing setting clear terminal can cancel the assistant channel frequency set by the internal UP/DOWN of the inverter to make the given frequency restore to the frequency given by the main given frequency channel.</p>
13	Switch between A setting and B setting	This function can realize the shifting between the frequency setting channels.
14	Switch between A setting and combination setting	The 13 th function can realize the shifting between A frequency given channel and B frequency given channel.

Set value	Function	Instructions																				
15	Switch between B setting and combination setting	The 14 th function can realize the shifting between A frequency given channel and the combination setting channel set by P00.09 The 15 th function can realize the shifting between B frequency given channel and the combination setting channel set by P00.09																				
16	Multi-step speed terminal 1	The 16 stage speeds can be set by the combination of digital state of four terminals. Note: multi-step speed 1 is the low bit, multi-step speed 4 is the high bit.																				
17	Multi-step speed terminal 2																					
18	Multi-step speed terminal 3																					
19	Multi-step speed terminal 4	<table border="1" style="margin-left: auto; margin-right: auto;"> <tr> <td>Multi-step speed 4</td> <td>Multi-step speed 3</td> <td>Multi-step speed 2</td> <td>Multi-step speed 1</td> </tr> <tr> <td style="text-align: center;">BIT3</td> <td style="text-align: center;">BIT2</td> <td style="text-align: center;">BIT1</td> <td style="text-align: center;">BIT0</td> </tr> </table>	Multi-step speed 4	Multi-step speed 3	Multi-step speed 2	Multi-step speed 1	BIT3	BIT2	BIT1	BIT0												
Multi-step speed 4	Multi-step speed 3	Multi-step speed 2	Multi-step speed 1																			
BIT3	BIT2	BIT1	BIT0																			
20	Multi-step speed pause	Shield the multi-step speed selection terminal function to keep the setting value at the current state.																				
21	ACC/DEC time selection 1	Select 4 ACC/DEC time by the combination of the 2 terminals.																				
22	ACC/DEC time selection 2		<table border="1" style="margin-left: auto; margin-right: auto;"> <thead> <tr> <th>Terminal 1</th> <th>Terminal 2</th> <th>ACC/DEC time selection</th> <th>Corresponding parameter</th> </tr> </thead> <tbody> <tr> <td style="text-align: center;">OFF</td> <td style="text-align: center;">OFF</td> <td>ACC/DEC time 1</td> <td>P00.11/P00.12</td> </tr> <tr> <td style="text-align: center;">ON</td> <td style="text-align: center;">OFF</td> <td>ACC/DEC time 2</td> <td>P08.00/P08.01</td> </tr> <tr> <td style="text-align: center;">OFF</td> <td style="text-align: center;">ON</td> <td>ACC/DEC time 3</td> <td>P08.02/P08.03</td> </tr> <tr> <td style="text-align: center;">ON</td> <td style="text-align: center;">ON</td> <td>ACC/DEC time 4</td> <td>P08.04/P08.05</td> </tr> </tbody> </table>	Terminal 1	Terminal 2	ACC/DEC time selection	Corresponding parameter	OFF	OFF	ACC/DEC time 1	P00.11/P00.12	ON	OFF	ACC/DEC time 2	P08.00/P08.01	OFF	ON	ACC/DEC time 3	P08.02/P08.03	ON	ON	ACC/DEC time 4
Terminal 1	Terminal 2	ACC/DEC time selection	Corresponding parameter																			
OFF	OFF	ACC/DEC time 1	P00.11/P00.12																			
ON	OFF	ACC/DEC time 2	P08.00/P08.01																			
OFF	ON	ACC/DEC time 3	P08.02/P08.03																			
ON	ON	ACC/DEC time 4	P08.04/P08.05																			
23	Simple PLC stop reset	Restart simple PLC and clear the memory state of PLC.																				
24	Simple PLC pause	Program pause during PLC implement. Run at the current speed stage. After cancel the function, simple PLC continues to run.																				
25	PID control pause	Temporal PID invalid and the inverter will output at the current frequency.																				
26	Traverse pause (stop at the current frequency)	The inverter will stop at the current output and after canceling the function, the inverter will continue to traverse run at the current frequency.																				
27	Traverse reset (return to the middle frequency)	The setting frequency of the inverter will come back to the middle frequency.																				
28	Counter reset	Counter clear																				
29	Torque control disabling	The inverter shifts from torque control mode to speed control mode.																				
30	ACC/DEC disabling	Ensure the inverter will not be affected by the external signals																				

Set value	Function	Instructions
		(except for the stopping command) and keep the current output frequency.
31	Counter triggering	Enable the pulse counter.
32	Length reset	Length counter clear
33	Frequency increasing/decreasing setting temporal clear	When the terminal closes, the frequency set by UP/DOWN can be cleared. All set frequency will be restored into the given frequency by the frequency command channel and the frequency will come back to the value after the frequency increasing or decreasing.
34	DC braking	The inverter will begin DC braking after the valid command.
35	Switch between motor1 and motor2	Motor-shifting can be controlled after the terminal is valid.
36	Switch commands to keypad	After the function terminal become valid, the running command channel will be shifted into keypad running command channel and the running command channel will come back to the original state if function terminal is invalid.
37	Switch commands to terminals	After the function terminal become valid, the running command channel will be shifted into terminal running command channel and the running command channel will come back to the original state if function terminal is invalid.
38	Switch commands to communication	After the function terminal become valid, the running command channel will be shifted into communication running command channel and the running command channel will come back to the original state if function terminal is invalid.
39	Pre-excitation commands	Perform pre-exciting if the terminal is valid until the terminal is invalid.
40	Power consumption clear	The power consumption will be cleared after the command is valid.
41	Power consumption retention	If the command is valid, the current running of the inverter will not affect its power consumption.
42-60	Reserved	
61	PID pole switching	Switch the output pole of PID and be used with P09.03
62-63	Reserved	

Related parameters list:

Function code	Name	Detailed instruction of parameters	Default value
P05.00	HDI input selection	0: High pulse input 1: Digital input	0
P05.01	S1 terminals function selection	0: No function	1
P05.02	S2 terminals function selection	1: Forward rotation operation	4
P05.03	S3 terminals function selection	2: Reverse rotation operation	7
P05.04	S4 terminals function selection	3: 3-wire control operation	0
P05.05	S5 terminals function selection	4: Forward jogging	0
P05.06	S6 terminals function selection	5: Reverse jogging	0
P05.07	S7 terminals function selection	6: Coast to stop	0
P05.08	S8 terminals function selection	7: Fault reset	0
P05.09	HDI terminal function selection	8: Operation pause 9: External fault input 10: Increasing frequency setting (UP) 11: Decreasing frequency setting (DOWN) 12: Frequency setting clear 13: Shift between A setting and B setting 14: Shift between combination setting and A setting 15: Shift between combination setting and B setting 16: Multi-step speed terminal 1 17: Multi-step speed terminal 2 18: Multi-step speed terminal 3 19: Multi- step speed terminal 4 20: Multi- step speed pause 21: ACC/DEC time 1 22: ACC/DEC time 2 23: Simple PLC stop reset 24: Simple PLC pause 25: PID control pause 26: Traverse Pause (stop at present frequency) 27: Traverse reset (return to center frequency) 28: Counter reset 29: Torque control disabling 30: ACC/DEC disabling 31: Counter triggering	0

Function code	Name	Detailed instruction of parameters	Default value
		32: Length reset 33: Cancel the frequency change setting temporarily 34: DC brake 35: Shift the motor 1 into motor 2 36: Shift the command to the keypad 37: Shift the command to the terminals 38: Shift the command to the communication 39: Pre-magnetized command 40: Consumption power clear 41: Consumption power holding 42–63: Reserved 61: PID pole switching 62–63: Reserved	
P05.10	Polarity selection of input terminal	0x000–0x1FF	0x000
P05.11	ON-OFF filter time	0.000–1.000s	0.010s
P05.12	Virtual terminals setting	0x000–0x1FF (0: Disabled, 1: Enabled) BIT0: S1 virtual terminal BIT1: S2 virtual terminal BIT2: S3 virtual terminal BIT3: S4 virtual terminal BIT4: S5 virtual terminal BIT5: S6 virtual terminal BIT6: S7 virtual terminal BIT7: S8 virtual terminal BIT8: HDI virtual terminal	0
P05.13	Terminals control running mode	0: 2-wire control 1 1: 2-wire control 2 2: 3-wire control 1 3: 3-wire control 2	0
P05.14	Switch-on delay of S1 terminal	0.000–50.000s	0.000s
P05.15	Switch-off delay of S1 terminal	0.000–50.000s	0.000s
P05.16	Switch-on delay of S2 terminal	0.000–50.000s	0.000s
P05.17	Switch-off delay of S2 terminal	0.000–50.000s	0.000s
P05.18	Switch-on delay of S3 terminal	0.000–50.000s	0.000s
P05.19	Switch-off delay of S3 terminal	0.000–50.000s	0.000s

Function code	Name	Detailed instruction of parameters	Default value
P05.20	Switch-on delay of S4 terminal	0.000–50.000s	0.000s
P05.21	Switch-off delay of S4 terminal	0.000–50.000s	0.000s
P05.22	Switch-on delay of S5 terminal	0.000–50.000s	0.000s
P05.23	Switch-off delay of S5 terminal	0.000–50.000s	0.000s
P05.24	Switch-on delay of S6 terminal	0.000–50.000s	0.000s
P05.25	Switch-off delay of S6 terminal	0.000–50.000s	0.000s
P05.26	Switch-on delay of S7 terminal	0.000–50.000s	0.000s
P05.27	Switch-off delay of S7 terminal	0.000–50.000s	0.000s
P05.28	Switch-on delay of S8 terminal	0.000–50.000s	0.000s
P05.29	Switch-off delay of S8 terminal	0.000–50.000s	0.000s
P05.30	Switch-on delay of HDI terminal	0.000–50.000s	0.000s
P05.31	Switch-off delay of HDI terminal	0.000–50.000s	0.000s
P07.39	Bus voltage at present fault		0
P17.12	Digital input terminals state		0

7.12 Digital output

UMI-B5 UL series inverters have 2 relay output terminals and 1 Y output terminal and 1 high speed pulse output terminal in the standard configuration. All functions of the digital output terminals are programmable by the function codes. The high-speed pulse output terminal HDO can be set to high-speed pulse output or digital output through function codes.

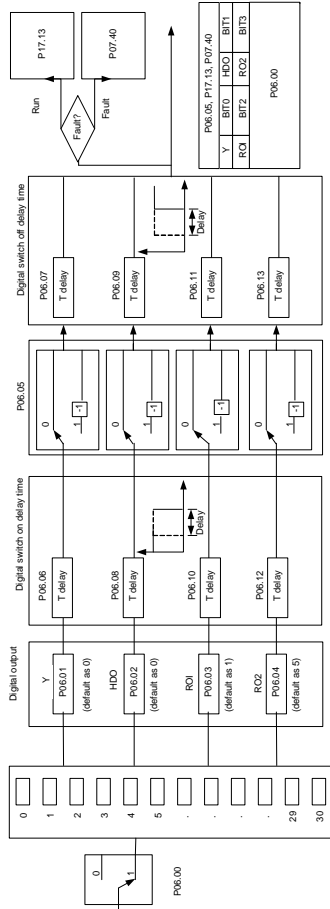

The table below describes the option of the four function parameters and selecting the repeated output terminal function is allowed.

Set value	Function	Instructions
0	Invalid	The output terminal has no function.
1	Running	Output ON signal when the inverter is running and there is frequency output.

Set value	Function	Instructions
2	Forward running	Output ON signal when the inverter is running forward and there is frequency output.
3	Reverse running	Output ON signal when the inverter is running reverse and there is frequency output.
4	Jogging	Output ON signal when the inverter is jogging and there is frequency output.
5	Inverter fault	Output ON signal when the inverter is in fault
6	FDT1	Refer to P08.32 and P08.33 for detailed information.
7	FDT2	Refer to P08.34 and P08.35 for detailed information.
8	Frequency arrival	Refer to P08.36 for detailed information.
9	Zero-speed running	Output ON signal when the output frequency and given frequency of the inverter is 0 at the same time.
10	Upper-limit frequency arrival	Output ON signal when the running frequency of the inverter is the upper limit frequency.
11	Upper-limit frequency arrival	Output ON signal when the running frequency of the inverter is the lower limit frequency.
12	Ready	When the main circuit and the control circuit is established and the protection function of the inverter is not active. The inverter is in the running state and it will output ON signal.
13	Pre-exciting	Output ON signal when the inverter is in the pre-exciting state.
14	Overload pre-alarm	Output ON signal if the inverter is beyond the pre-alarm point. Refer to P11.08–P11.10 for the detailed instruction.
15	Underload pre-alarm	Output ON signal if the inverter is beyond the pre-alarm point. Refer to P11.11–P11.12 for the detailed instruction.
16	Simple PLC stage completion	Output signal if the simple PLC stage is completed.
17	Simple PLC cycle completion	Output signal if the simple PLC cycle is completed.
18	Set counting arrival	Output ON signal if the detected counting exceeds the set value of P08.25.
19	Fixed counting arrival	Output ON signal if the detected counting exceeds the set value of P08.26.
20	External fault valid	Output ON signal if external fault occurs.
21	Length arrival	Output ON signal if the actual detected length exceeds the set length by P08.19.
22	Running time arrival	Output ON signal if the accumulative running time of the inverter exceeds the setting time by P08.27.
23	MODBUS	Output corresponding signal according to the setting value of

Set value	Function	Instructions
	communication virtual terminal output	MODBUS. Output ON signal if the setting value is 1 and output OFF signal if the setting value is 0.
24	PROFIBUS communication virtual terminal output	Output corresponding signal according to the setting value of PROFIBUS/CANOPEN. Output ON signal if the setting value is 1 and output OFF signal if the setting value is 0.
26	Voltage establishment finished	The output is valid when the bus voltage reaches the undervoltage point.
27-30	Reserved	

Related parameters list:

Function code	Name	Detailed instruction of parameters	Default value
P06.00	HDO output	0: Open collector pole high speed pulse output 1: Open collector pole output	0
P06.01	Y output	0: Invalid	0
P06.02	HDO output	1: In operation	0
P06.03	Relay RO1 output	2: Forward rotation operation	1
P06.04	Relay RO2 output	3: Reverse rotation operation 4: Jogging operation 5: The inverter fault 6: Frequency degree test FDT1 7: Frequency degree test FDT2 8: Frequency arrival 9: Zero speed running 10: Upper limit frequency arrival 11: Lower limit frequency arrival 12: Ready for operation 13: Pre-magnetizing 14: Overload pre-alarm 15: Underload pre-alarm 16: Completion of simple PLC stage 17: Completion of simple PLC cycle 18: Setting count value arrival 19: Defined count value arrival 20: External fault valid 21: Length arrival	5

Function code	Name	Detailed instruction of parameters	Default value
		22: Running time arrival 23: MODBUS communication virtual terminals output 24: PROFIBUS/CANopen communication virtual terminals output 25: Ethernet communication virtual terminals output 26: Voltage establishment finished 27-30: Reserved	
P06.05	Polarity of output terminals	0x00-0x0F	0x00
P06.06	Y switch-on delay time	0.000-50.000s	0.000s
P06.07	Y switch-off delay time	0.000-50.000s	0.000s
P06.08	HDO switch-on delay time	0.000-50.000s (valid only when P06.00=1)	0.000s
P06.09	HDO switch-off delay time	0.000-50.000s (valid only when P06.00=1)	0.000s
P06.10	RO1 switch-on delay time	0.000-50.000s	0.000s
P06.11	RO1 switch-off delay time	0.000-50.000s	0.000s
P06.12	RO2 switch-on delay time	0.000-50.000s	0.000s
P06.13	RO2 switch-off delay time	0.000-50.000s	0.000s
P07.38	The max temperature at present fault		0
P17.13	Digital output terminals state		0

7.13 Simple PLC

Simple PLC function is also a multi-step speed generator. The inverter can change the running frequency, direction to meet the need of processing according to the running time automatically. In the past, this function needs to be assisted by external PLC, but now the inverter can realize this function by itself.

The series inverters can control 16-stage speed with 4 groups of ACC/DEC time.

The multi-function digital output terminals or multi-function relay output an ON signal when the set PLC finishes a circle (or a stage).

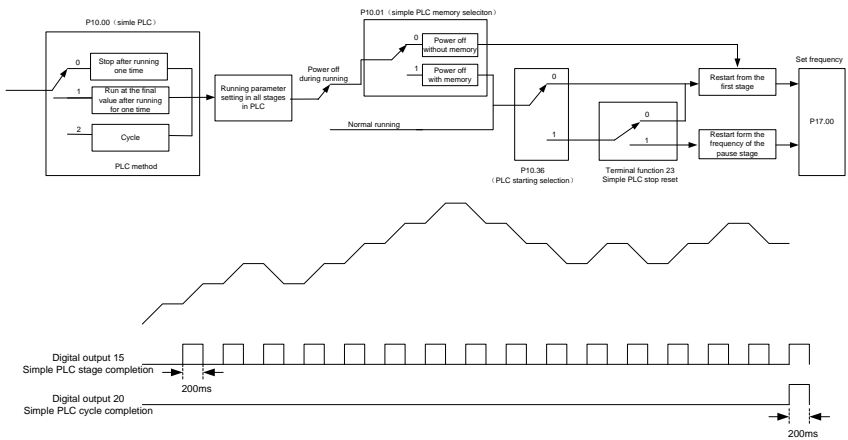

Related parameters list:

Function code	Name	Detailed instruction of parameters	Default value
P10.00	Simple PLC	0: Stop after running once 1: Run at the final value after running once 2: Cycle running	0
P10.01	Simple PLC memory	0: Power loss without memory 1: Power loss memory	0
P10.02	Multi-step speed 0	-100.0–100.0%	0.0%
P10.03	The running time of step 0	0.0–6553.5s (min)	0.0s
P10.04	Multi-step speed 1	-100.0–100.0%	0.0%
P10.05	The running time of step 1	0.0–6553.5s (min)	0.0s
P10.06	Multi-step speed 2	-100.0–100.0%	0.0%
P10.07	The running time of step 2	0.0–6553.5s (min)	0.0s
P10.08	Multi-step speed 3	-100.0–100.0%	0.0%
P10.09	The running time of step 3	0.0–6553.5s (min)	0.0s

Function code	Name	Detailed instruction of parameters	Default value
P10.10	Multi-step speed 4	-100.0–100.0%	0.0%
P10.11	The running time of step 4	0.0–6553.5s (min)	0.0s
P10.12	Multi-step speed 5	-100.0–100.0%	0.0%
P10.13	The running time of step 5	0.0–6553.5s (min)	0.0s
P10.14	Multi-step speed 6	-100.0–100.0%	0.0%
P10.15	The running time of step 6	0.0–6553.5s (min)	0.0s
P10.16	Multi-step speed 7	-100.0–100.0%	0.0%
P10.17	The running time of step 7	0.0–6553.5s (min)	0.0s
P10.18	Multi-step speed 8	-100.0–100.0%	0.0%
P10.19	The running time of step 8	0.0–6553.5s (min)	0.0s
P10.20	Multi-step speed 9	-100.0–100.0%	0.0%
P10.21	The running time of step 9	0.0–6553.5s (min)	0.0s
P10.22	Multi-step speed 10	-100.0–100.0%	0.0%
P10.23	The running time of step 10	0.0–6553.5s (min)	0.0s
P10.24	Multi-step speed 11	-100.0–100.0%	0.0%
P10.25	The running time of step 11	0.0–6553.5s (min)	0.0s
P10.26	Multi-step speed 12	-100.0–100.0%	0.0%
P10.27	The running time of step 12	0.0–6553.5s (min)	0.0s
P10.28	Multi-step speed 13	-100.0–100.0%	0.0%
P10.29	The running time of step 13	0.0–6553.5s (min)	0.0s
P10.30	Multi-step speed 14	-100.0–100.0%	0.0%
P10.31	The running time of step 14	0.0–6553.5s (min)	0.0s
P10.32	Multi-step speed 15	-100.0–100.0%	0.0%
P10.33	The running time of step 15	0.0–6553.5s (min)	0.0s
P10.36	PLC restart	0: Restart from the first stage 1: Continue to run from the stop frequency	0
P10.34	Simple PLC 0–7 step ACC/DEC time	0x0000–0xFFFF	0000
P10.35	Simple PLC 8–15 step ACC/DEC time	0x0000–0xFFFF	0000
P05.01–P05.09	Digital input function selection	23: Simple PLC stop reset 24: Simple PLC pause	
P06.01–P06.04	Digital output function selection	15: Underload pre-alarm 16: Completion of simple PLC stage	
P17.00	Setting frequency	0.00Hz–P00.03 (max output frequency)	0.00Hz
P17.27	Simple PLC and the current stage of the multi-step speed	0–15	

7.14 Multi-step speed running

Set the parameters when the inverter carries out multi-step speed running. UMI-B5 UL series inverters can set 16 stage speed which can be selected by the combination code of multi-step speed terminals 1–4. They correspond to multi-step speed 0 to 15.

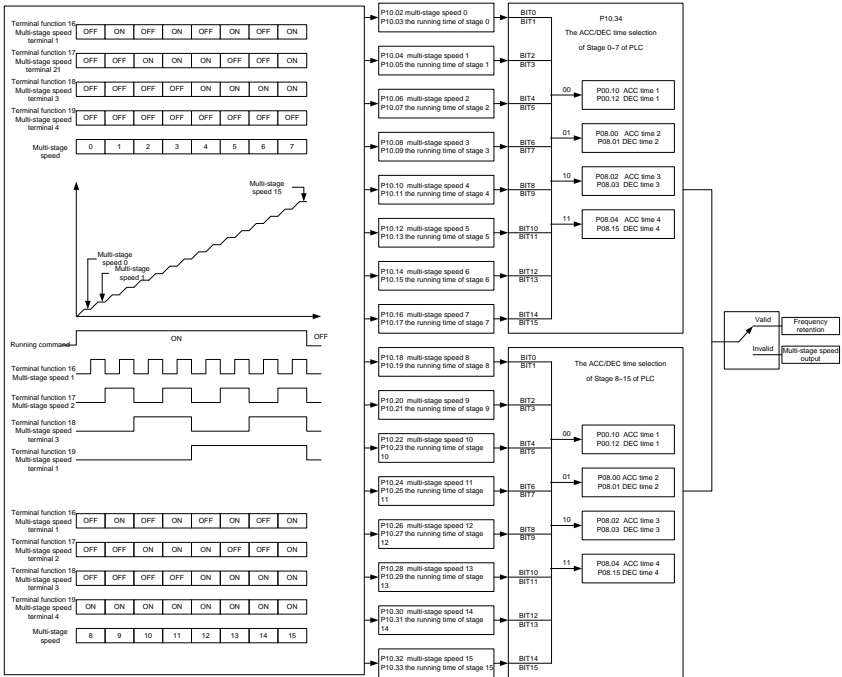

Related parameters list:

Function code	Name	Detailed instruction of parameters	Default value
P10.02	Multi-step speed 0	-100.0–100.0%	0.0%
P10.03	The running time of step 0	0.0–6553.5s (min)	0.0s
P10.04	Multi-step speed 1	-100.0–100.0%	0.0%
P10.05	The running time of step 1	0.0–6553.5s (min)	0.0s
P10.06	Multi-step speed 2	-100.0–100.0%	0.0%
P10.07	The running time of step 2	0.0–6553.5s (min)	0.0s
P10.08	Multi-step speed 3	-100.0–100.0%	0.0%
P10.09	The running time of step 3	0.0–6553.5s (min)	0.0s
P10.10	Multi-step speed 4	-100.0–100.0%	0.0%
P10.11	The running time of step 4	0.0–6553.5s (min)	0.0s

Function code	Name	Detailed instruction of parameters	Default value
P10.12	Multi-step speed 5	-100.0–100.0%	0.0%
P10.13	The running time of step 5	0.0–6553.5s (min)	0.0s
P10.14	Multi-step speed 6	-100.0–100.0%	0.0%
P10.15	The running time of step 6	0.0–6553.5s (min)	0.0s
P10.16	Multi-step speed 7	-100.0–100.0%	0.0%
P10.17	The running time of step 7	0.0–6553.5s (min)	0.0s
P10.18	Multi-step speed 8	-100.0–100.0%	0.0%
P10.19	The running time of step 8	0.0–6553.5s (min)	0.0s
P10.20	Multi-step speed 9	-100.0–100.0%	0.0%
P10.21	The running time of step 9	0.0–6553.5s (min)	0.0s
P10.22	Multi-step speed 10	-100.0–100.0%	0.0%
P10.23	The running time of step 10	0.0–6553.5s (min)	0.0s
P10.24	Multi-step speed 11	-100.0–100.0%	0.0%
P10.25	The running time of step 11	0.0–6553.5s (min)	0.0s
P10.26	Multi-step speed 12	-100.0–100.0%	0.0%
P10.27	The running time of step 12	0.0–6553.5s (min)	0.0s
P10.28	Multi-step speed 13	-100.0–100.0%	0.0%
P10.29	The running time of step 13	0.0–6553.5s (min)	0.0s
P10.30	Multi-step speed 14	-100.0–100.0%	0.0%
P10.31	The running time of step 14	0.0–6553.5s (min)	0.0s
P10.32	Multi-step speed 15	-100.0–100.0%	0.0%
P10.33	The running time of step 15	0.0–6553.5s (min)	0.0s
P10.34	Simple PLC 0–7 step ACC/DEC time	0x0000–0XFFFF	0000
P10.35	Simple PLC 8–15 step ACC/DEC time	0x0000–0XFFFF	0000
P05.01–P05.09	Digital input function selection	16: Multi-step speed terminal 1 17: Multi-step speed terminal 2 18: Multi-step speed terminal 3 19: Multi-step speed terminal 4 20: Multi-step speed pause	
P17.27	Simple PLC and the current step of the multi-step speed	0–15	0

7.15 PID control

PID control is commonly used to control the procedure through the controlled procedure. Adjust the output frequency by proportional, integral, differential operation with the dispersion of the target signals to stabilize the value on the target. It is possible to apply to the flow, pressure and temperature control. The basic control is shown in the following figure.

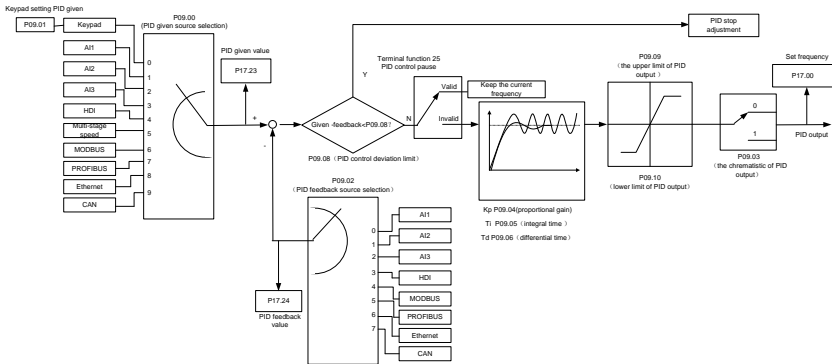

Simple illustration of the PID control operation and adjustment:

Proportional adjustment (Kp): when there is an error between the feedback and the reference, a proportional adjustment will be output. If the error is constant, the adjustment will be constant, too. Proportional adjustment can respond to the feedback change quickly, but it cannot realize non-fault control. The gain will increase with the adjustment speed, but too much gain may cause vibration. The adjustment method is: set a long integral time and derivative time to 0 first. Secondly make the system run by proportional adjustment and change the reference. And then watch the error of the feedback signal and the reference. If the static error is available (for example, increasing the reference, the feedback will be less than the reference after a stable system), continue to increase the gain, vice versa. Repeat the action until the static error achieves a little value.

Integral time (Ti): the output adjustment will accumulate if there is an error between the feedback and the reference. The adjustment will keep on increasing until the error disappears. If the error is existent all the time, the integration adjustor can cancel the static error effectively. Vibration may occur as a result of unstable system caused by repeated over-adjustment if the integration adjustor is too strong. The features of this kind of vibration are: the fluctuating feedback signal (around the reference) and increasing traverse range will cause vibration. Adjust the integral time parameter from a big value to a little one to change the integral time and monitor the result until a stable system speed is available.

Derivative time (Td): when the error between the feedback and the reference, a proportional adjustment will be output. The adjustment only depends on the direction and value of the error change other than the error itself. The derivation adjustment controls the change of feedback signals according to the changing trend when it fluctuates. Because the derivation may enlarge the interference to the system, especially the frequent-changing interference, use it carefully.

When P00.06, P00.07=7 or P04.27=6, the running mode of the inverter is procedure PID control.

7.15.1 General steps of PID parameters setting:

a) Ensure the gain P

When ensure the gain P, firstly cancel the PID integration and derivation (set $T_i=0$ and $T_d=0$, see the PID parameter setting for detailed information) to make proportional adjustment is the only method to PID. Set the input as 60%–70% of the permitted Max. Value and increase gain P from 0 until the system vibration occurs, vice versa, and record the PID value and set it to 60%–70% of the current value. Then the gain P commissioning is finished.

b) Ensure the integral time T_i

After ensuring the gain P, set an original value of a bigger integral time and decrease it until the system vibration occurs, vice versa, until the system vibration disappear. Record the T_i and set the integral time to 150%–180% of the current value. Then integral time commissioning is finished.

c) Ensure the derivative time T_d

Generally, it is not necessary to set T_d which is 0.

If it needs to be set, set it to 30% of the value without vibration via the same method with P and T_i .

d) Commissioning the system with and without load and then adjust the PID parameter until it is available.

7.15.2 PID inching

After setting the PID control parameters, inching is possible by following means:

Control the overshoot

Shorten the derivative time and prolong the integral time when overshoot occurs.

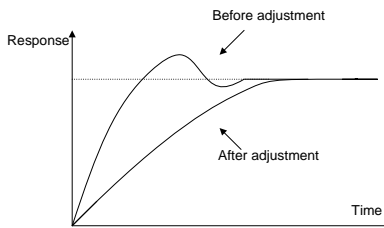

Achieve the stable state as soon as possible

Shorten the integral time (T_i) and prolong the derivative time (T_d) even the overshoot occurs, but the control should be stable as soon as possible.

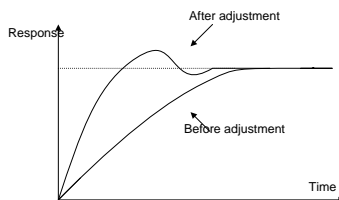

Control long vibration

If the vibration periods are longer than the set value of integral time (Ti), it is necessary to prolong the integral time (Ti) to control the vibration for the strong integration.

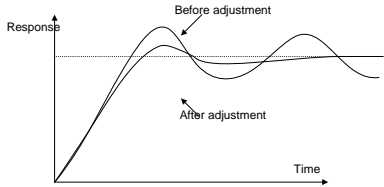

Control short vibration

Short vibration period and the same set value with the derivative time (Td) mean that the derivative time is strong. Shortening the derivative time (Td) can control the vibration. When setting the derivative time as 0.00 (namely no derivation control) is useless to control the vibration, decrease the gain.

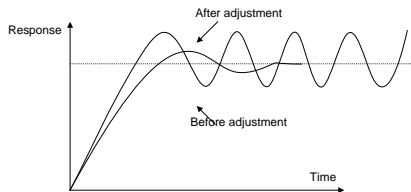

Related parameters list:

Function code	Name	Detailed instruction of parameters	Default value
P09.00	PID reference source	0: Keypad (P09.01) 1: AI1 2: AI2 3: AI3 4: HDI 5: Multi-step speed set 6: MODBUS communication set 7: PROFIBUS/CANopen communication set 8: Ethernet communication set 9: Reserved	0
P09.01	Keypad PID preset	-100.0%~100.0%	0.0%
P09.02	PID feedback source	0: AI1 1: AI2 2: AI3	0

Function code	Name	Detailed instruction of parameters	Default value
		3: HDI 4: MODBUS communication feedback 5: PROFIBUS/CANopen communication feedback 6: Ethernet communication feedback 7: Reserve	
P09.03	PID output feature	0: PID output is positive 1: PID output is negative	0
P09.04	Proportional gain (Kp)	0.00–100.00	1.00
P09.05	Integral time (Ti)	0.00–10.00s	0.10s
P09.06	Differential time (Td)	0.00–10.00s	0.00s
P09.07	Sampling cycle (T)	0.000–10.000s	0.100s
P09.08	PID control deviation limit	0.0–100.0%	0.0%
P09.09	Output upper limit of PID	P09.10–100.0% (max frequency or max voltage)	100.0%
P09.10	Output lower limit of PID	-100.0%–P09.09 (max frequency or max voltage)	0.0%
P09.11	Detection value of feedback offline	0.0–100.0%	0.0%
P09.12	Detection time of feedback offline	0.0–3600.0s	1.0s
P09.13	PID adjustment	0x0000–0x1111 LED ones: 0: Keep on integral adjustment when the frequency achieves the upper and low limit; the integration shows the change between the reference and the feedback unless it reaches the internal integral limit. When the trend between the reference and the feedback changes, it needs more time to offset the impact of continuous working and the integration will change with the trend. 1: Stop integral adjustment when the frequency achieves the upper and low limit. If the integration keeps stable, and the trend between the reference and the feedback changes, the integration will change with the trend quickly. LED tens: P00.08 is 0 0: The same with the setting direction; if the output of PID adjustment is different from the current running direction, the internal will output 0 forcedly. 1: Opposite to the setting direction	0x0001

Function code	Name	Detailed instruction of parameters	Default value
		LED hundreds: P00.08 is 0 0: Limit to the maximum frequency 1: Limit to frequency A LED thousands: 0: A+B frequency, the buffer of A frequency is invalid 1: A+B frequency, the buffer of A frequency is valid ACC/DEC is determined by ACC time 4 of P08.04	
P17.00	Setting frequency	0.00Hz–P00.03 (the max frequency)	0.00Hz
P17.23	PID reference	-100.0–100.0%	0.0%
P17.24	PID feedback	-100.0–100.0%	0.0%

7.16 Traverse running

Traverse is applied in some industries such as textile, chemical fiber and cases where traverse and convolution is required. The working flowchart is as below:

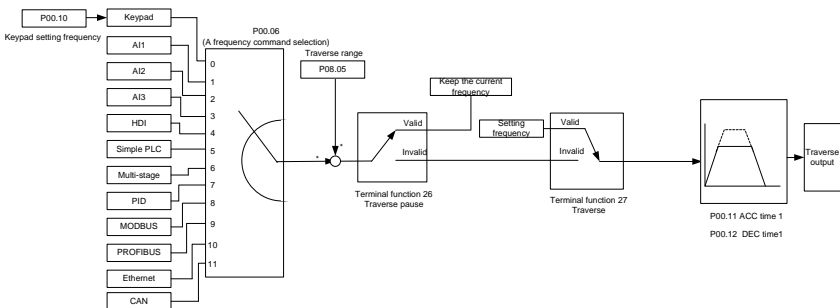

Function code	Name	Detailed instruction of parameters	Default value
P00.03	Max output frequency	P00.03–400.00Hz	60.00Hz
P00.06	A frequency command	0: Keypad 1: AI1 2: AI2 3: AI3 4: High-speed pulse HDI setting 5: Simple PLC program setting 6: Multi-step speed running setting 7: PID control setting 8: MODBUS communication setting 9: PROFIBUS/CANopen communication setting 10: Ethernet communication setting (reserved)	0

Function code	Name	Detailed instruction of parameters	Default value
		11: Reserved	
P00.11	ACC time 1	0.0–3600.0s	Depend on model
P00.12	DEC time 1	0.0–3600.0s	
P05.01–P05.09	Digital input function selection	26: Traverse Pause (stop at present frequency) 27: Traverse reset (return to center frequency)	
P08.15	Traverse range	0.0–100.0% (relative to the set frequency)	0.0%
P08.16	Sudden jumping frequency range	0.0–50.0% (relative to the traverse range)	0.0%
P08.17	Traverse boost time	0.1–3600.0s	5.0s
P08.18	Traverse declining time	0.1–3600.0s	5.0s

7.17 Pulse counter

UMI-B5 UL series inverters support pulse counter which can input counting pulse through HDI terminal. When the actual length is longer than or equal to the set length, the digital output terminal can output length arrival pulse signal and the corresponding length will clear automatically.

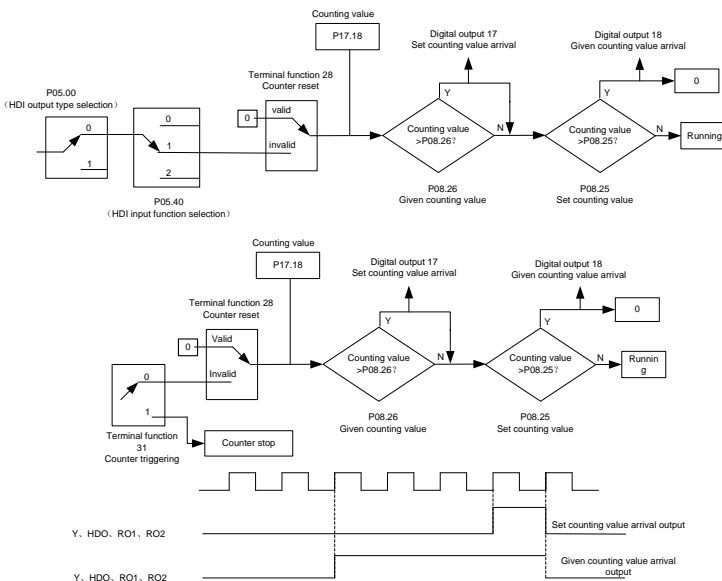

Function code	Name	Detailed instruction of parameters	Default value
P05.00	HDI input selection	0: High pulse input. 1: Digital input.	0

Function code	Name	Detailed instruction of parameters	Default value
P05.40	Corresponding setting of the upper limit of AI2		0
P05.01–P05.09	Digital input function selection	28: Counter reset 31: Counter trigger	
P06.01–P06.04	Digital output function selection	17: Completion of simple PLC cycle 18: Setting count value arrival	
P08.25	Setting counting value	P08.26–65535	0
P08.26	Reference counting value	0–P08.25	0
P17.18	Counting value	0–65535	0

7.18 Fixed-length control

UMI-B5 UL series inverters support fixed-length control function which can input length counting pulse through HDI, and then count the actual length according to the internal counting formula. If the actual length is longer than or equal to the set length, the digital output terminal can output the length arrival pulse signal of 200ms and the corresponding length will clear automatically.

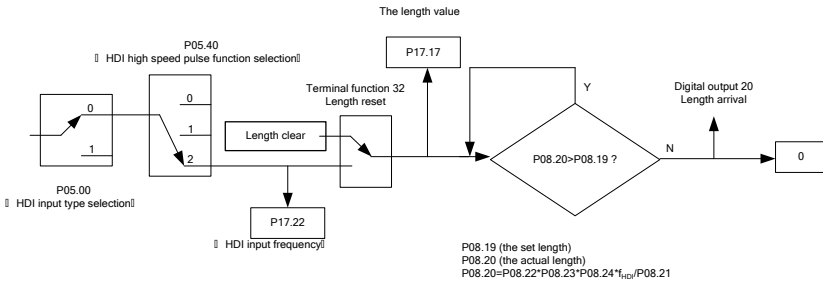

Note: the length arrival belongs to pulse output and the lasting time is 200ms.

Function code	Name	Detailed instruction of parameters	Default value
P05.00	HDI input selection	0: High pulse input. 1: Digital input.	0
P05.49	HDI high-speed pulse input function selection	0: Frequency setting input 1: Counter input 2: Length counting input	0
P05.01–P05.09	Digital input function selection	32: Length reset	
P06.01–P06.04	Digital output function selection	20: Length arrival	
P08.19	Setting length	0–65535m	0

Function code	Name	Detailed instruction of parameters	Default value
P08.20	Actual length	0-65535m	0
P08.21	Pulse per rotation	1-10000	1
P08.22	Axle perimeter	0.01-100.00cm	10.00
P08.23	Length ratio	0.001-10.000	1.000
P08.24	Length correcting coefficient	0.001-1.000	1.000
P17.17	Length	0-65535	0
P17.22	HDI input frequency	Display HDI input frequency Range: 0.00-50.00kHz	0.00 kHz

7.19 Fault procedure

UMI-B5 UL series inverters provide sufficient fault procedure information for the convenience of user's application.

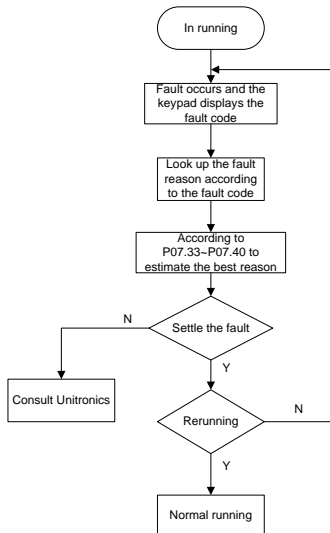

Related parameters list:

Function code	Name	Detailed instruction of parameters	Default value
P07.27	Present fault type	0: No fault 1: IGBT U phase protection (OUt1) 2: IGBT V phase protection (OUt2) 3: IGBT W phase protection (OUt3) 4: OC1	0
P07.28	Type of the last fault		
P07.29	Type of the last but one fault		
P07.30	Type of the last but two		

Function code	Name	Detailed instruction of parameters	Default value
	fault	5: OC2	
P07.31	Type of the last but three fault	6: OC3 7: OV1	
P07.32	Type of the last but four fault	8: OV2 9: OV3 10: UV 11: Motor overload (OL1) 12: The inverter overload (OL2) 13: Input side phase loss (SPI) 14: Output side phase loss (SPO) 15: Overheat of the rectifier module (OH1) 16: Overheat fault of the inverter module (OH2) 17: External fault (EF) 18: 485 communication fault (CE) 19: Current detection fault (ItE) 20: Motor autotune fault (tE) 21: EEPROM operation fault (EEP) 22: PID response offline fault (PIDE) 23: Braking unit fault (bCE) 24: Running time arrival (END) 25: Electrical overload (OL3) 26: Panel communication fault (PCE) 27: Parameter uploading fault (UPE) 28: Parameter downloading fault (DNE) 29: PROFIBUS communication fault (E-DP) 30: Ethernet communication fault (E-NET) 31: CANopen communication fault (E-CAN) 32: Grounding short circuit fault 1 (ETH1) 33: Grounding short circuit fault 2 (ETH2) 34: Speed deviation fault (dEu) 35: Maladjustment (STo) 36: Undervoltage fault (LL)	
P07.33	Running frequency at present fault		0.00Hz
P07.34	Ramp reference frequency at present fault		0.00Hz
P07.35	Output voltage at the present fault		0V
P07.36	Output current at present fault		0.0A

Function code	Name	Detailed instruction of parameters	Default value
P07.37	Bus voltage at present fault		0.0V
P07.38	The max temperature at present fault		32°F (0.0°C)
P07.39	Input terminals state at present fault		0
P07.40	Output terminals state at present fault		0
P07.41	Running frequency at the last fault		0.00Hz
P07.42	Ramp reference frequency at the last fault		0.00Hz
P07.43	Output voltage at the last fault		0V
P07.44	The output current at the last fault		0.0A
P07.45	Bus voltage at the last fault		0.0V
P07.46	The max temperature at the last fault		32°F (0.0°C)
P07.47	Input terminals state at the last fault		0
P07.48	Output terminals state at the last fault		0
P07.49	Running frequency at the last but one fault		0.00Hz
P07.50	Output voltage at the last but one faults		0.00Hz
P07.51	Output current at the last but one faults		0V
P07.52	Output current at the last but one fault		0.0A
P07.53	Bus voltage at the last but one fault		0.0V
P07.54	The max temperature at the last but one fault		32°F (0.0°C)
P07.55	Input terminals state at the last but one fault		0
P07.56	Output terminals state at the last but one fault		0

8 Fault tracking

8.1 What this chapter contains

This chapter tells how to reset faults and view fault history. It also lists all alarm and fault messages including the possible cause and corrective actions.

	<p>⚡ Only qualified electricians are allowed to maintain the inverter. Read the safety instructions in chapter Safety precautions before working on the inverter.</p>
---	---

8.2 Alarm and fault indications

Fault is indicated by LEDs. See **Operation Procedure**. When **TRIP** light is on, an alarm or fault message on the panel display indicates abnormal inverter state. Using the information given in this chapter, most alarm and fault cause can be identified and corrected. If no, contact UNITRONICS office.

8.3 How to reset

The inverter can be reset by pressing the keypad key **STOP/RST**, through digital input, or by switching the power light. When the fault has been removed, the motor can be restarted.

8.4 Fault history

Function codes P07.27–P07.32 store 6 recent faults. Function codes P07.33–P07.40, P07.41–P7.48, P07.49–P07.56 show drive operation data at the time the latest 3 faults occurred.

8.5 Fault instruction and solution

Do as the following after the inverter fault:

1. Check to ensure there is nothing wrong with the keypad. If no, contact the local UNITRONICS office.
2. If there is nothing wrong, check P07 and ensure the corresponding recorded fault parameters to confirm the real state when the current fault occurs by all parameters.
3. See the following table for detailed solution and check the corresponding abnormal state.
4. Eliminate the fault and ask for related help.
5. Check to eliminate the fault and carry out fault reset to run the inverter.

Code	Fault	Cause	Solution
OUt1	IGBT U phase protection	<ul style="list-style-type: none"> ●The acceleration is too fast. ●There is damage to the internal to IGBT of the phase. ●The connection of the driving wires is not good. ●The grounding is not good. 	<ul style="list-style-type: none"> ● Increase acc. Time. ● Change the power unit. ● Check the driving wires. ● Check if there is strong interference to the external equipment.
OUt2	IGBT V phase protection		
OUt3	IGBT W phase protection		
OC1	Accelerating overcurrent	<ul style="list-style-type: none"> ●The acceleration or deceleration is too fast. 	<ul style="list-style-type: none"> ● Increase the acc. Time. ● Check the input power.

Code	Fault	Cause	Solution
OC2	Decelerating overcurrent	<ul style="list-style-type: none"> ●The voltage of the grid is too low. 	<ul style="list-style-type: none"> ●Select the inverter with a larger power.
OC3	Constant overcurrent	<ul style="list-style-type: none"> ●The power of the inverter is too low. ●The load transients or is abnormal. ●The grounding is short circuited or the output is phase loss. ●There is strong external interference. ●The overvoltage stall protection is not open. 	<ul style="list-style-type: none"> ●Check if the load is short circuited (the grounding short circuited or the wire short circuited) or the rotation is not smooth. ●Check the output configuration. ●Check if there is strong interference. ●Check the setting of related function codes.
OV1	Accelerating overvoltage	<ul style="list-style-type: none"> ●The input voltage is abnormal. ●There is large energy feedback. ●No braking components. ●Braking energy is not open. 	<ul style="list-style-type: none"> ●Check the input power. ●Check if the DEC time of the load is too short or the inverter starts during the rotation of the motor or it needs to increase the energy consumption components. ●Install the braking components. ●Check the setting of related function codes.
OV2	Decelerating overvoltage		
OV3	Constant overvoltage		
UV	Bus undervoltage fault	<ul style="list-style-type: none"> ●The voltage of the power supply is too low. ●The overvoltage stall protection is not open. 	<ul style="list-style-type: none"> ●Check the input power of the supply line ●Check the setting of related function codes
OL1	Motor overload	<ul style="list-style-type: none"> ●The voltage of the power supply is too low. ●The motor setting rated current is incorrect. ●The motor stall or load transients is too strong. 	<ul style="list-style-type: none"> ●Check the power of the supply line ●Reset the rated current of the motor ●Check the load and adjust the torque lift
OL2	Inverter overload	<ul style="list-style-type: none"> ●The acceleration is too fast. ●Reset the rotating motor. ●The voltage of the power supply is too low. ●The load is too heavy. ●Close loop vector control, reverse direction of the code panel and long low-speed operation. 	<ul style="list-style-type: none"> ●Increase the ACC time ●Avoid the restarting after stopping. ●Check the power of the supply line ●Select an inverter with bigger power. ●Select a proper motor.

Code	Fault	Cause	Solution
OL3	Electrical overload	<ul style="list-style-type: none"> ●The inverter will report overload pre-alarm according to the set value. 	<ul style="list-style-type: none"> ●Check the load and the overload pre-alarm point.
SPI	Input phase loss	<ul style="list-style-type: none"> ●Phase loss or fluctuation of input R, S, T. 	<ul style="list-style-type: none"> ●Check input power ●Check installation distribution
SPO	Output phase loss	<ul style="list-style-type: none"> ●U, V, W phase loss input (or serious asymmetrical three phase of the load). 	<ul style="list-style-type: none"> ●Check the output distribution. ●Check the motor and cable.
OH1	Rectifying module overheated	<ul style="list-style-type: none"> ●Air duct jam or fan damage. ●Ambient temperature is too high. ●The time of overload running is too long. 	<ul style="list-style-type: none"> ●Refer to the overcurrent solution. ●Redistribute dredge the wind channel or change the fan. ●Lower the ambient temperature. ●Check and reconnect.
OH2	IGBT overheated		<ul style="list-style-type: none"> ●Change the power. ●Change the power unit. ●Change the main control panel.
EF	External fault	<ul style="list-style-type: none"> ●SI external fault input terminals action 	<ul style="list-style-type: none"> ●Check the external device input.
CE	485 communication fault	<ul style="list-style-type: none"> ●The baud rate setting is incorrect. ●Fault occurs to the communication wiring. ●The communication address is wrong. ●There is strong interference to the communication. 	<ul style="list-style-type: none"> ●Set proper baud rate. ●Check the communication connection distribution. ●Set proper communication address. ●Chang or replace the connection distribution or improve the anti-interference capability.
ItE	Current-detecting fault	<ul style="list-style-type: none"> ●The connection of the control board is not good. ●Assistant power is bad. ●Hall components is broken ●The modifying circuit is abnormal. 	<ul style="list-style-type: none"> ●Check the connector and re-plug. ●Change the hall. ●Change the main control panel.
tE	Motor-autotuning fault	<ul style="list-style-type: none"> ●The motor capacity does not comply with the inverter capability. ●The rated parameter of the motor does not set correctly. ●The offset between the parameters from autotune and the standard parameter is huge 	<ul style="list-style-type: none"> ●Change the inverter mode ●Set the rated parameter according to the motor name plate. ●Empty the motor load and re-identify. ●Check the motor connection and set the parameter. ●Check if the upper limit frequency

Code	Fault	Cause	Solution
		<ul style="list-style-type: none"> ●Autotune overtime. 	is above 2/3 of the rated frequency.
EEP	EEPROM operation fault	<ul style="list-style-type: none"> ●Error of controlling the write and read of the parameters. ●Damage to EEPROM. 	<ul style="list-style-type: none"> ●Press STOP/RST to reset. ●Change the main control panel.
PIDE	PID feedback outline fault	<ul style="list-style-type: none"> ●PID feedback offline. ●PID feedback source disappear. 	<ul style="list-style-type: none"> ●Check the PID feedback signal. ●Check the PID feedback source.
bCE	Braking unit fault	<ul style="list-style-type: none"> ●Braking circuit fault or damage to the braking pipes. ●The external braking resistor is not sufficient. 	<ul style="list-style-type: none"> ●Check the braking unit and, change new braking pipe. ●Increase the braking resistor.
ETH1	Grounding shortcut fault 1	<ul style="list-style-type: none"> ●The output of the inverter is short circuited with the ground. ●There is fault in the current detection circuit. 	<ul style="list-style-type: none"> ●Check if the connection of the motor is normal or not. ●Change the hall. ●Change the main control panel.
ETH2	Grounding shortcut fault 2	<ul style="list-style-type: none"> ●The output of the inverter is short circuited with the ground. ●There is fault in the current detection circuit. ●There is a great difference between the actual motor power setting and the inverter power. 	<ul style="list-style-type: none"> ●Check if the connection of the motor is normal or not. ●Change the hall. Change the main control panel. ●Reset the correct motor parameter.
dEu	Speed deviation fault	<ul style="list-style-type: none"> ●The load is too heavy or stalled. 	<ul style="list-style-type: none"> ●Check the load and ensure it is normal. Increase the detection time. ●Check whether the control parameters are normal.
STo	Maladjustment fault	<ul style="list-style-type: none"> ●The control parameters of the synchronous motors not set properly. ●The autotune parameter is not right. ●The inverter is not connected to the motor. 	<ul style="list-style-type: none"> ●Check the load and ensure it is normal. ●Check whether the control parameter is set properly or not. ●Increase the maladjustment detection time.
END	Running time arrival	<ul style="list-style-type: none"> ●The actual running time of the inverter is above the internal setting running time. 	<ul style="list-style-type: none"> ●Ask for the supplier and adjust the setting running time.
PCE	Keypad communication	<ul style="list-style-type: none"> ●The connection of the keypad wires is not good or broken. 	<ul style="list-style-type: none"> ●Check the keypad wires and ensure whether there is mistake.

Code	Fault	Cause	Solution
	fault	<ul style="list-style-type: none"> ●The keypad wire is too long and affected by strong interference. ●There is circuit fault on the communication of the keypad and main board. 	<ul style="list-style-type: none"> ●Check the environment and avoid the interference source. ●Change the hardware and ask for service.
UPE	Parameters uploading fault	<ul style="list-style-type: none"> ●The connection of the keypad wires is not good or broken. ●The keypad wire is too long and affected by strong interference. ●Communication fault. 	<ul style="list-style-type: none"> ●Check the keypad wires and ensure whether there is mistake. ●Change the hardware and ask for service. ●Change the hardware and ask for service.
DNE	Parameters downloading fault	<ul style="list-style-type: none"> ●The connection of the keypad wires is not good or broken. ●The keypad wire is too long and affected by strong interference. ●There is mistake on the data storage of the keypad. 	<ul style="list-style-type: none"> ●Check the keypad wires and ensure whether there is mistake. ●Change the hardware and ask for service. ●Repack-up the data in the keypad.
LL	Electronic underload fault	<ul style="list-style-type: none"> ●The inverter will report the underload pre-alarm according to the set value. 	<ul style="list-style-type: none"> ●Check the load and the underload pre-alarm point.
E-DP	PROFIBUS/CANOPEN communication fault	<ul style="list-style-type: none"> ●Communication address is not correct. ●Corresponding resistor is not dialed. ●The files of main stop GSD does not set sound. 	<ul style="list-style-type: none"> ●Check related setting.
E-NET	Ethernet communication fault	<ul style="list-style-type: none"> ●The Ethernet address is not set right. ●The Ethernet communication is not selected to right. ●The ambient interference is too strong. 	<ul style="list-style-type: none"> ●Check the related setting. Check the communication method selection. ●Check the environment and avoid the interference.
E-CAN	CANopen communication fault	<ul style="list-style-type: none"> ●The connection is not sound. ●Corresponding resistor is not dialed. ●The communication is uneven. 	<ul style="list-style-type: none"> ●Check the connection. ●Draw out the correspond resistor. ●Set the same baud rate.

8.6 Common fault analysis

8.6.1 The motor does not work

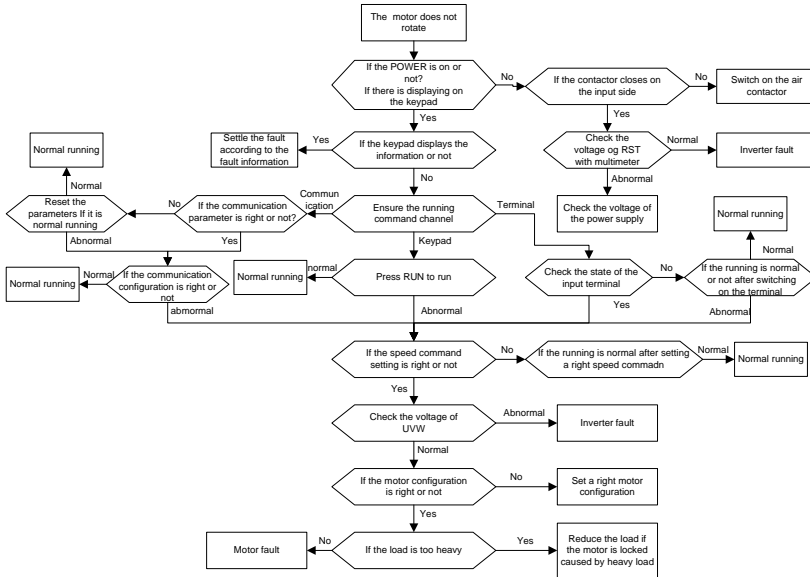

8.6.2 Motor vibration

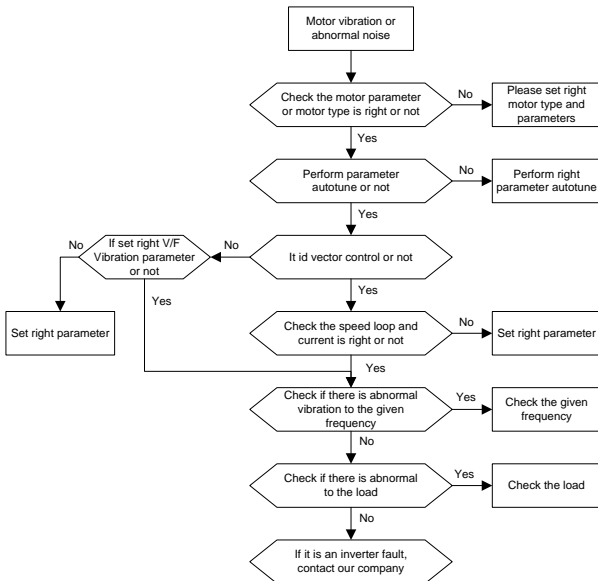

8.6.3 Overvoltage

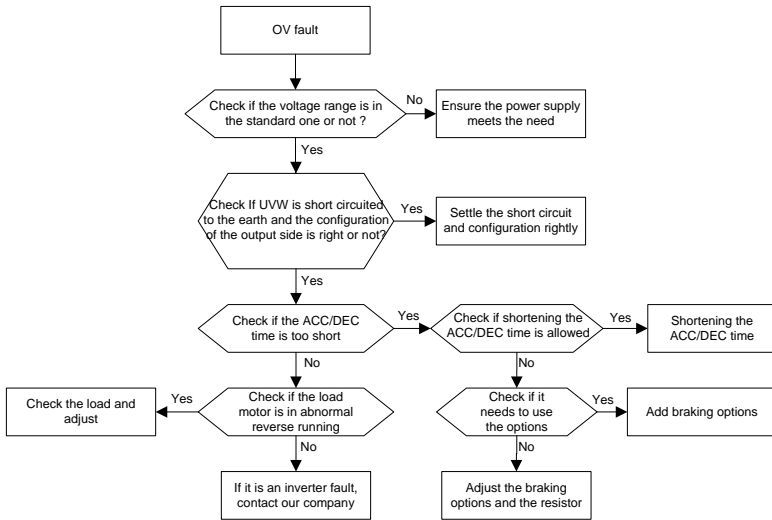

8.6.4 Undervoltage fault

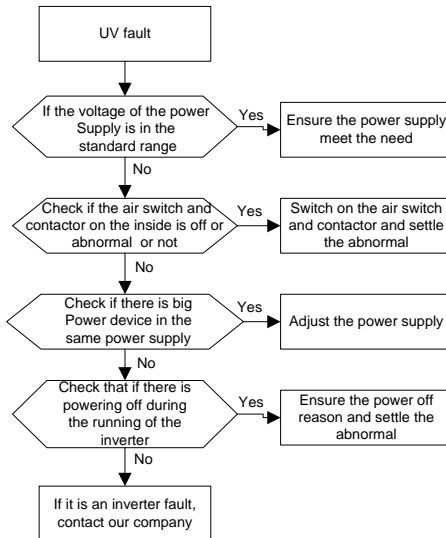

8.6.5 Abnormal heating of the motor

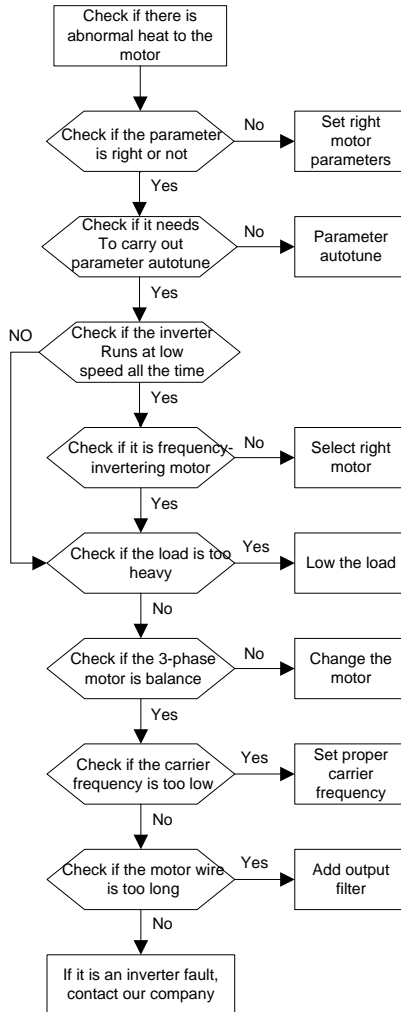

8.6.6 Overheat of the inverter

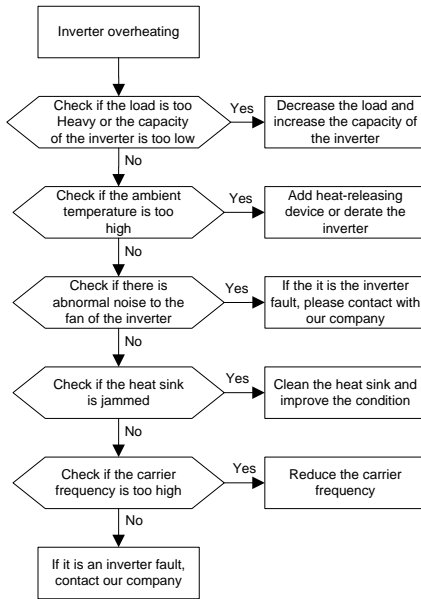

8.6.7 Motor stall during ACC

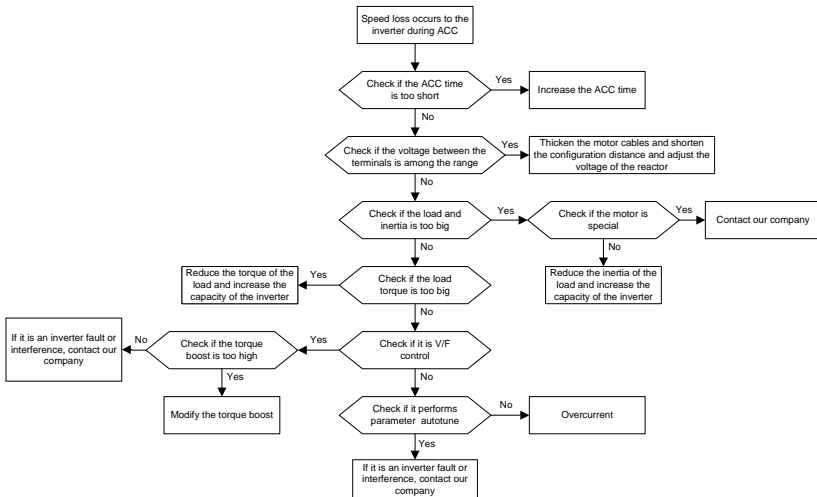

8.6.8 overcurrent

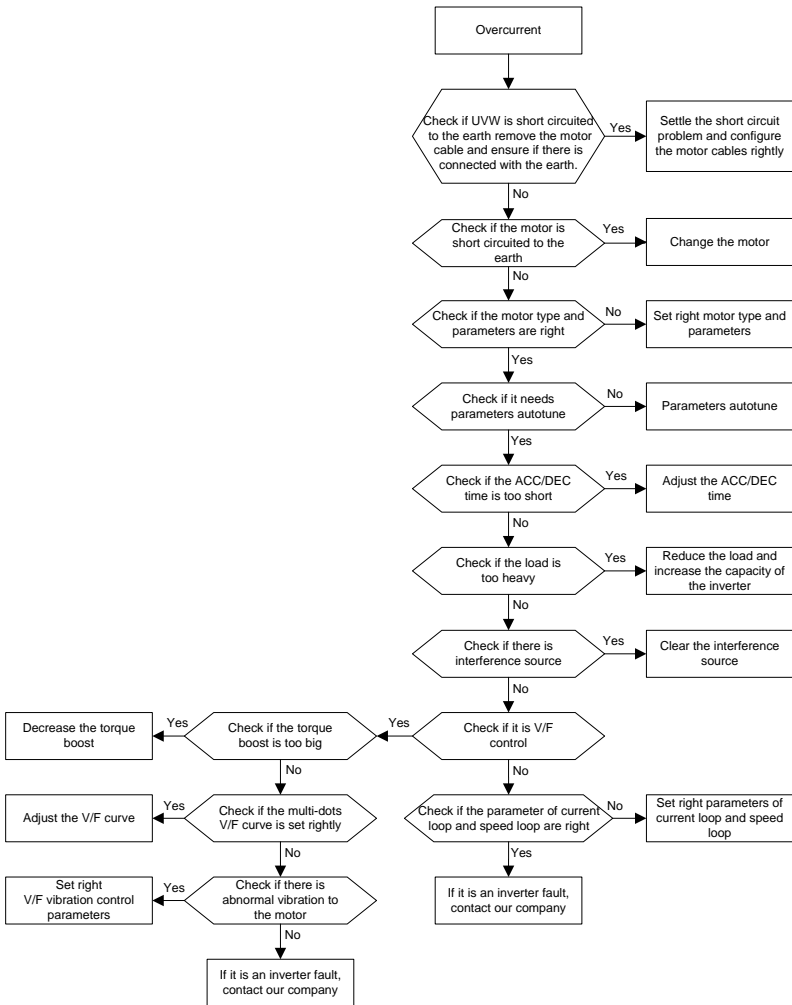

9 Maintenance and hardware diagnosis

9.1 What this chapter contains.

The chapter contains preventive maintenance instructions of the inverter.

9.2 Maintenance intervals

If installed in an appropriate environment, the inverter requires very little maintenance. The table lists the routine maintenance intervals recommended by UNITRONICS.

Checking		Item	Method	Criterion
Ambient environment		Check the ambient temperature, humidity and vibration and ensure there is no dust, gas, oil fog and water drop.	Visual examination and instrument test	Conforming to the manual
		Ensure there are no tools or other foreign or dangerous objects	Visual examination	There are no tools or dangerous objects.
Voltage		Ensure the main circuit and control circuit are normal.	Measurement by millimeter	Conforming to the manual
Keypad		Ensure the display is clear enough	Visual examination	The characters are displayed normally.
		Ensure the characters are displayed totally	Visual examination	Conforming to the manual
Main circuit	For public use	Ensure the screws are tightened securely	Tighten up	NA
		Ensure there is no distortion, crackles, damage or color-changing caused by overheating and aging to the machine and insulator.	Visual examination	NA
		Ensure there is no dust and dirtiness	Visual examination	NA Note: if the color of the copper blocks change, it does not mean that there is something wrong with the features.
	The lead of conductors	Ensure that there is no distortion or color-changing of the conductors caused by overheating.	Visual examination	NA
Ensure that there are no		Visual examination	NA	

Checking		Item	Method	Criterion
		crackles or color-changing of the protective layers.		
	Terminals seat	Ensure that there is no damage	Visual examination	NA
	Filter capacitors	Ensure that there is no weeping, color-changing, crackles and cassis expansion.	Visual examination	NA
		Ensure the safety valve is in the right place.	Estimate the usage time according to the maintenance or measure the static capacity.	NA
		If necessary, measure the static capacity.	Measure the capacity by instruments.	The static capacity is above or equal to the original value *0.85.
	Resistors	Ensure whether there is replacement and splitting caused by overheating.	Smelling and visual examination	NA
		Ensure that there is no offline.	Visual examination or remove one ending to coagulate or measure with multimeter	The resistors are in $\pm 10\%$ of the standard value.
	Transformer and reactor	Ensure there is no abnormal vibration, noise and smelling,	Hearing, smelling and visual examination	NA
	Electromagnetism contactors and relays	Ensure whether there is vibration noise in the workrooms.	Hearing	NA
		Ensure the contactor is good enough.	Visual examination	NA
Control circuit	PCB and plugs	Ensure there are no loose screws and contactors.	Fasten up	NA
		Ensure there is no smelling and color-changing.	Smelling and visual examination	NA
		Ensure there are no crackles, damage distortion and rust.	Visual examination	NA
		Ensure there is no weeping and	Visual examination	NA

Checking		Item	Method	Criterion
		distortion to the capacitors.	or estimate the usage time according to the maintenance information	
Cooling system	Cooling fan	Estimate whether there is abnormal noise and vibration.	Hearing and Visual examination or rotate with hand	Stable rotation
		Estimate there is no losses screw.	Tighten up	NA
		Ensure there is no color-changing caused by overheating.	Visual examination or estimate the usage time according to the maintenance information	NA
	Ventilating duct	Ensure whether there is stuff or foreign objection in the cooling fan, air vent.	Visual examination	NA

Consult the local service representative for more details on the maintenance. Visit the official website.

9.3 Cooling fan

The inverter’s cooling fan has a minimum life span of 25,000 operating hours. The actual life span depends on the inverter usage and ambient temperature.

The operating hours can be found through P07.14.

Fan failure can be predicted by the increasing noise from the fan bearings. If the inverter is operated in a critical part of a process, fan replacement is recommended once these symptoms appear. Spare fans are also available.

Replacing the cooling fan

	◇ Read and follow the instructions in chapter Safety Precautions . Ignoring the instructions would cause physical injury or death, or damage to the equipment.
---	---

1. Stop the inverter and disconnect it from the AC power source and wait for at least the time designated on the inverter.
2. Loose the fan cable from the clip (remove the shell for the inverters of 220V 1–20HP (0.75–15kW) and 460V 2–40HP (1.5–30kW)).
3. Disconnect the fan cable.
4. Remove the fan.
5. Install the new fan in the inverter, put the fan cables in the clip and then fix the inverter well.
6. Connect the power supply.

9.4 Capacitors

9.4.1 Capacitors reforming

The DC bus capacitors must be reformed according to the operation instruction if the inverter has been stored for a long time. The storing time is counted from the producing date other than the delivery data which has been marked in the serial number of the inverter.

Time	Operational principle
Storing time less than 1 year	Operation without charging
Storing time 1-2 years	Connect with the power for 1 hour before first ON command
Storing time 2-3 years	Use power surge to charge for the inverter <ul style="list-style-type: none"> • charging 25% rated voltage for 30 minutes • charging 50% rated voltage for 30 minutes • charging 75% rated voltage for 30 minutes • charging 100% rated voltage for 30 minutes
Storing time more than 3 years	Use power surge to charge for the inverter <ul style="list-style-type: none"> • charging 25% rated voltage for 2 hours • charging 50% rated voltage for 2 hours • charging 75% rated voltage for 2 hours • charging 100% rated voltage for 2 hours

Use voltage-adjusting power supply to charge the inverter:

The right selection of the voltage-adjusting power supply depends on the supply power of the inverter. Single phase 220V AC/2A power surge is applied to the inverter of single/three-phase 220V AC. The inverter of single/three-phase 220V AC can apply single phase 220V AC/2A power surge (L+ to R, N to S or T). All DC bus capacitors can charge at the same time because there is one rectifier.

High-voltage inverter needs enough voltage (for example, 460V) during charging. The small capacitor power (2A is enough) can be used because the capacitor nearly does not need current when charging.

The operation method of inverter charging through resistors (LEDs):

The charging time is at least 60 minutes if charge the DC bus capacitor directly through supply power. This operation is available on normal temperature and no-load condition and the resistor should be serially connected in the 3-phase circuits of the power supply:

460V drive device: 1k/100W resistor. LED of 100W can be used when the power voltage is no more than 460V. But if used, the light may be off or weak during charging.

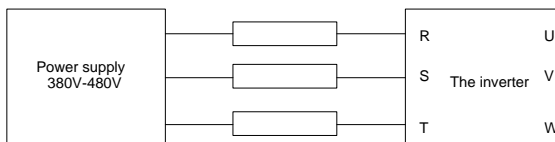

460V charging illustration of the driven device

9.4.2 Change electrolytic capacitors



⇨ Read and follow the instructions in chapter *Safety Precautions*. Ignoring the instructions may cause physical injury or death, or damage to the equipment.

Change electrolytic capacitors if the working hours of electrolytic capacitors in the inverter are above 35000. Contact the local offices or dial our national service hotline (400-700-9997) for detailed operation.

9.5 Power cable



⇨ Read and follow the instructions in chapter *Safety Precautions*. Ignoring the instructions may cause physical injury or death, or damage to the equipment.

1. Stop the drive and disconnect it from the power line. Wait for at least the time designated on the inverter.
2. Check the tightness of the power cable connections.
3. Restore power.

10 Communication protocol

10.1 What this chapter contains

This chapter describes the communication protocol of UMI-B5 UL series inverters.

The UMI-B5 UL series inverters provide RS485 communication interface. It adopts international standard ModBus communication protocol to perform master-slave communication. The user can realize centralized control through PC/PLC, upper control PC, etc. (set the control command, running frequency of the inverter, modify related function codes, monitor and control the operating state and fault information of the inverter and so on) to adapt specific application requirements.

10.2 Brief instruction to Modbus protocol

Modbus protocol is a software protocol and common language which is applied in the electrical controller. With this protocol, the controller can communicate with other devices via network (the channel of signal transmission or the physical layer, such as RS485). And with this industrial standard, the controlling devices of different manufacturers can be connected to an industrial network for the convenient of being monitored.

There are two transmission modes for Modbus protocol: ASCII mode and RTU (Remote Terminal Units) mode. On one Modbus network, all devices should select same transmission mode and their basic parameters, such as baud rate, digital bit, check bit, and stopping bit should have no difference.

Modbus network is a controlling network with single-master and multiple slaves, which means that there is only one device performs as the master and the others are the slaves on one Modbus network. The master means the device which has active talking right to send message to Modbus network for the controlling and inquiring to other devices. The slave means the passive device which sends data message to the Modbus network only after receiving the controlling or inquiring message (command) from the master (response). After the master sends message, there is a period of time left for the controlled or inquired slaves to response, which ensure there is only one slave sends message to the master at a time for the avoidance of singles impact.

Generally, the user can set PC, PLC, IPC and HMI as the masters to realize central control. Setting certain device as the master is a promise other than setting by a bottom or a switch or the device has a special message format. For example, when the upper monitor is running, if the operator clicks sending command bottom, the upper monitor can send command message actively even it cannot receive the message from other devices. In this case, the upper monitor is the master. And if the designer makes the inverter send the data only after receiving the command, then the inverter is the slave.

The master can communicate with any single slave or with all slaves. For the single-visiting command, the slave should feedback a response message; for the broadcasting message from the master, the slave does not need to feedback the response message.

10.3 Application of the inverter

The Modbus protocol of the inverter is RTU mode and the physical layer is RS485.

10.3.1 RS485

The interface of RS485 works on semiduplex and its data signal applies differential transmission which is called balance transmission, too. It uses twisted pairs, one of which is defined as A (+) and the other is defined as B (-). Generally, if the positive electrical level between sending drive A and B is among +2~+6V, it is logic“1”, if the electrical level is among -2V~-6V, it is logic“0”.

485+ on the terminal board corresponds to A and 485- to B.

Communication baud rate means the binary bit number in one second. The unit is bit/s (bps). The higher the baud rate is, the quicker the transmission speed is and the weaker the anti-interference is. If the twisted pairs of 0.56mm (24AWG) are applied as the communication cables, the max Transmission distance is as below:

Baud rate	Max. transmission distance	Baud rate	Max. transmission distance
2400BPS	1800m	9600BPS	800m
4800BPS	1200m	19200BPS	600m

It is recommended to use shield cables and make the shield layer as the grounding wires during RS485 remote communication.

In the cases with less devices and shorter distance, it is recommended to use 120Ω terminal resistor as the performance will be weakened if the distance increase even though the network can perform well without load resistor.

10.3.2.1 Single application

Figure 10-1 is the site Modbus connection figure of single inverter and PC. Generally, the computer does not have RS485 interface, the RS232 or USB interface of the computer should be converted into RS485 by converter. Connect the A terminal of RS485 to the 485+ terminal of the inverter and B to the 485- terminal. It is recommended to use the shield twisted pairs. When applying RS232-RS485 converter, if the RS232 interface of the computer is connected to the RS232 interface of the converter, the wire length should be as short as possible within the length of 15m. It is recommended to connect the RS232-RS485 converter to the computer directly. If using USB-RS485 converter, the wire should be as short as possible, too.

Select a right interface to the upper monitor of the computer (select the interface of RS232-RS485 converter, such as COM1) after the wiring and set the basic parameters such as communication baud rate and digital check bit to the same as the inverter.

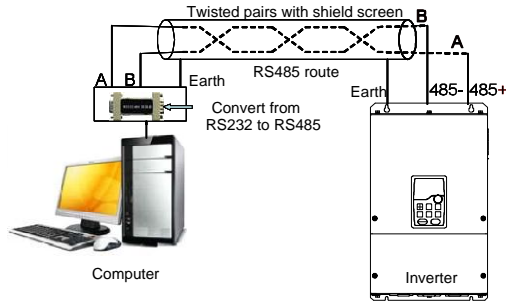

Figure 10-1 RS485 physical connection in single application

10.3.1.2 Multi-application

In the real multi-application, the chrysanthemum connection is used.

Chrysanthemum chain connection is required in the RS485 industrial fieldbus standards. The two ends are connected to terminal resistors of 120Ω which is shown as Figure 10-2. Figure 10-3 is the simply connection figure and Figure 10-4 is the real application figure.

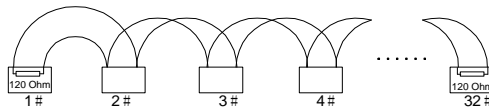

Figure 10-2 Chrysanthemum connection

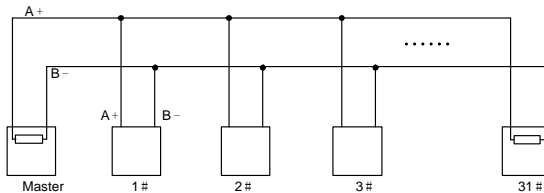

Figure 10-3 Chrysanthemum connection

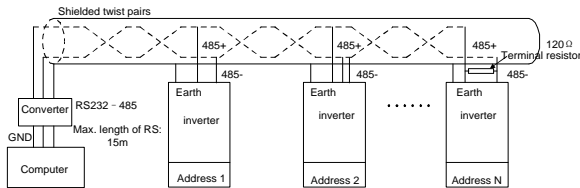

Figure 10-4 Chrysanthemum connection applications

It is recommended that you use shield cables when multiple devices are connected. The basic parameters of the devices, such as baud rate and digital check bit in RS485 should be the same and there should be no repeated address.

10.3.2 RTU mode

10.3.2.1 RTU communication frame format

If the controller is set to communicate by RTU mode in Modbus network every 8bit byte in the message includes two 4Bit hex characters. Compared with ACSII mode, this mode can send more data at the same baud rate.

Code system

- 1 start bit
- 7 or 8 digital bit, the minimum valid bit can be sent firstly. Every 8 bit frame includes two hex characters (0...9, A...F)
- 1 even/odd check bit . If there is no checkout, the even/odd check bit is inexistent.
- 1 end bit (with checkout), 2 Bit (no checkout)

Error detection field

- CRC

The data format is illustrated as below:

11-bit character frame (BIT1–BIT8 are the data bits)

Start bit	BIT1	BIT2	BIT3	BIT4	BIT5	BIT6	BIT7	BIT8	Check bit	End bit
-----------	------	------	------	------	------	------	------	------	-----------	---------

10-bit character frame (BIT1–BIT7 are the data bits)

Start bit	BIT1	BIT2	BIT3	BIT4	BIT5	BIT6	BIT7	Check bit	End bit
-----------	------	------	------	------	------	------	------	-----------	---------

In one character frame, the digital bit takes effect. The start bit, check bit and end bit is used to send the digital bit right to the other device. The digital bit, even/odd checkout and end bit should be set as the same in real application.

The Modbus minimum idle time between frames should be no less than 3.5 bytes. The network device is detecting, even during the interval time, the network bus. When the first field (the address field) is received, the corresponding device decodes next transmitting character. When the interval time is at least 3.5 byte, the message ends.

The whole message frame in RTU mode is a continuous transmitting flow. If there is an interval time (more than 1.5 bytes) before the completion of the frame, the receiving device will renew the uncompleted message and suppose the next byte as the address field of the new message. As such, if the new message follows the previous one within the interval time of 3.5 bytes, the receiving device will deal with it as the same with the previous message. If these two phenomena all happen during the transmission, the CRC will generate a fault message to respond to the sending devices.

The standard structure of RTU frame:

START	T1-T2-T3-T4 (transmission time of 3.5 bytes)
ADDR	Communication address: 0–247 (decimal system) (0 is the broadcast address)
CMD	03H: read slave parameters 06H: write slave parameters

DATA (N-1) ... DATA (0)	The data of 2*N bytes are the main content of the communication as well as the core of data exchanging
CRC CHK low bit	Detection value: CRC (16BIT)
CRC CHK high bit	
END	T1-T2-T3-T4 (transmission time of 3.5 bytes)

10.3.2.2 RTU communication frame error checkout

Various factors (such as electromagnetic interference) may cause error in the data transmission. For example, if the sending message is a logic “1”, A-B potential difference on RS485 should be 6V, but in reality, it may be -6V because of electromagnetic interference, and then the other devices take the sent message as logic “0” . If there is no error checkout, the receiving devices will not find the message is wrong and they may give incorrect response which cause serious result. So the checkout is essential to the message.

The theme of checkout is that: the sender calculate the sending data according to a fixed formula, and then send the result with the message. When the receiver gets this message, they will calculate another result according to the same method and compare it with the sending one. If two results are the same, the message is correct. If no, the message is incorrect.

The error checkout of the frame can be divided into two parts: the bit checkout of the byte and the whole data checkout of the frame (CRC check).

Bit checkout of the byte

The user can select different bit checkouts or non-checkout, which impacts the check bit setting of each byte.

The definition of even checkout: add an even check bit before the data transmission to illustrate the number of “1” in the data transmission is odd number or even number. When it is even, the check byte is “0”, otherwise, the check byte is”1”. This method is used to stabilize the parity of the data.

The definition of odd checkout: add an odd check bit before the data transmission to illustrate the number of “1” in the data transmission is odd number or even number. When it is odd, the check byte is “0”, otherwise, the check byte is”1”. This method is used to stabilize the parity of the data.

For example, when transmitting “11001110”, there are five “1” in the data. If the even checkout is applied, the even check bit is “1”; if the odd checkout is applied; the odd check bit is “0”. The even and odd check bit is calculated on the check bit position of the frame. And the receiving devices also carry out even and odd checkout. If the parity of the receiving data is different from the setting value, there is an error in the communication.

CRC check

The checkout uses RTU frame format. The frame includes the frame error detection field which is based on the CRC calculation method. The CRC field is two bytes, including 16 figure binary values. It is added into the frame after calculated by transmitting device. The receiving device recalculates the CRC of the received frame and compares them with the value in the received CRC field. If the two

CRC values are different, there is an error in the communication.

During CRC, 0xFFFF will be stored. And then, deal with the continuous 6-above bytes in the frame and the value in the register. Only the 8Bit data in every character is effective to CRC, while the start bit, the end and the odd and even check bit is ineffective.

The calculation of CRC applies the international standard CRC checkout principles. When the user is editing CRC calculation, he can refer to the related standard CRC calculation to write the required CRC calculation program.

Here provided a simple function of CRC calculation for the reference (programmed with C language):

```
unsigned int crc_cal_value(unsigned char *data_value,unsigned char data_length)
{
int i;
unsigned int crc_value=0xffff;
while(data_length--)
{
  crc_value^=*data_value++;
  for(i=0;i<8;i++)
  {
if(crc_value&0x0001)crc_value=(crc_value>>1)^0xa001;
    else crc_value=crc_value>>1;
  }
}
return(crc_value);
}
```

In ladder logic, CKSM calculated the CRC value according to the frame with the table inquiry. The method is advanced with easy program and quick calculation speed. But the ROM space the program occupied is huge. So use it with caution according to the program required space.

10.4 RTU command code and communication data illustration

10.4.1 Command code: 03H

03H (correspond to binary 0000 0011), read N words (Word) (the max continuous reading is 16 words)

Command code 03H means that if the master read data from the inverter, the reading number depends on the "data number" in the command code. The max continuous reading number is 16 and the parameter address should be continuous. The byte length of every data is 2 (one word). The following command format is illustrated by hex (a number with "H" means hex) and one hex occupies one byte.

The command code is used to read the working stage of the inverter.

For example, read continuous 2 data content from 0004H from the inverter with the address of 01H (read the content of data address of 0004H and 0005H), the frame structure is as below:

RTU master command message (from the master to the inverter)

START	T1-T2-T3-T4 (transmission time of 3.5 bytes)
ADDR	01H
CMD	03H
High bit of the start bit	00H
Low bit of the start bit	04H
High bit of data number	00H
Low bit of data number	02H
Low bit of CRC	85H
High bit of CRC	CAH
END	T1-T2-T3-T4 (transmission time of 3.5 bytes)

T1-T2-T3-T4 between START and END is to provide at least the time of 3.5 bytes as the leisure time and distinguish two messages for the avoidance of taking two messages as one message.

ADDR = 01H means the command message is sent to the inverter with the address of 01H and ADDR occupies one byte

CMD=03H means the command message is sent to read data from the inverter and CMD occupies one byte

“Start address” means reading data from the address and it occupies 2 bytes with the fact that the high bit is in the front and the low bit is in the behind.

“Data number” means the reading data number with the unit of word. If the “start address” is 0004H and the “data number” is 0002H, the data of 0004H and 0005H will be read.

CRC occupies 2 bytes with the fact that the high bit is in the front and the low bit is in the behind.

RTU slave response message (from the inverter to the master)

START	T1-T2-T3-T4 (transmission time of 3.5 bytes)
ADDR	01H
CMD	03H
Byte number	04H
Data high bit of address 0004H	13H
Data low bit of address 0004H	88H
Data high bit of address 0005H	00H
Data low bit of address 0005H	00H
Low bit of CRC	7EH
High bit of CRC	9DH
END	T1-T2-T3-T4 (transmission time of 3.5 bytes)

The meaning of the response is that:

ADDR = 01H means the command message is sent to the inverter with the address of 01H and ADDR occupies one byte

CMD=03H means the message is received from the inverter to the master for the response of reading command and CMD occupies one byte

“Byte number” means all byte number from the byte (excluding the byte) to CRC byte (excluding the byte). 04 means there are 4 byte of data from the “byte number” to “CRC CHK low bit”, which are “digital address 0004H high bit”, “digital address 0004H low bit”, “digital address 0005H high bit” and “digital address 0005H low bit”.

There are 2 bytes stored in one data with the fact that the high bit is in the front and the low bit is in the behind of the message, the data of data address 0004H is 1388H, and the data of data address 0005H is 0000H.

CRC occupies 2 bytes with the fact that the high bit is in the front and the low bit is in the behind.

10.4.2 Command code: 06H

06H (correspond to binary 0000 0110), write one word (Word)

The command means that the master write data to the inverter and one command can write one data other than multiple dates. The effect is to change the working mode of the inverter.

For example, write 5000 (1388H) to 0004H from the inverter with the address of 02H, the frame structure is as below:

RTU master command message (from the master to the inverter)

START	T1-T2-T3-T4 (transmission time of 3.5 bytes)
ADDR	02H
CMD	06H
High bit of writing data address	00H
Low bit of writing data address	04H
Data content	13H
Data content	88H
Low bit of CRC	C5H
High bit of CRC	6EH
END	T1-T2-T3-T4 (transmission time of 3.5 bytes)

RTU slave response message (from the inverter to the master)

START	T1-T2-T3-T4 (transmission time of 3.5 bytes)
ADDR	02H
CMD	06H
High bit of writing data address	00H
Low bit of writing data address	04H
High bit of data content	13H
Low bit of data content	88H
Low bit of CRC	C5H
High bit of CRC	6EH
END	T1-T2-T3-T4 (transmission time of 3.5 bytes)

Note: section 10.2 and 10.3 mainly describe the command format, and the detailed application will be mentioned in 10.8 with examples.

10.4.3 Command code 08H for diagnosis

Meaning of sub-function codes

Sub-function Code	Description
0000	Return to inquire information data

For example: The inquiry information string is same as the response information string when the loop detection to address 01H of driver is carried out.

The RTU request command is:

START	T1-T2-T3-T4 (transmission time of 3.5 bytes)
ADDR	01H
CMD	08H
High bit of sub-function code	00H
Low bit of sub-function code	00H
High bit of data content	12H
Low bit of data content	ABH
Low bit of CRC	ADH
High bit of CRC	14H
END	T1-T2-T3-T4 (transmission time of 3.5 bytes)

The RTU response command is:

START	T1-T2-T3-T4 (transmission time of 3.5 bytes)
ADDR	01H
CMD	08H
High bit of sub-function code	00H
Low bit of sub-function code	00H
High bit of data content	12H
Low bit of data content	ABH
Low bit of CRC	ADH
High bit of CRC	14H
END	T1-T2-T3-T4 (transmission time of 3.5 bytes)

10.4.4 Command code: 10H, continuous writing

Command code 10H means that if the master writes data to the inverter, the data number depends on the “data number” in the command code. The max continuous reading number is 16.

For example, write 5000 (1388H) to 0004H of the inverter whose slave address is 02H and 50 (0032H) to 0005H, the frame structure is as below:

The RTU request command is:

START	T1-T2-T3-T4 (transmission time of 3.5 bytes)
ADDR	02H
CMD	10H

High bit of write data	00H
Low bit of write data	04H
High bit of data number	00H
Low bit of data number	02H
Byte number	04H
High bit of data 0004H	13H
Low bit of data 0004H	88H
High bit of data 0005H	00H
Low bit of data 0005H	32H
Low bit of CRC	C5H
High bit of CRC	6EH
END	T1-T2-T3-T4 (transmission time of 3.5 bytes)

The RTU response command is:

START	T1-T2-T3-T4 (transmission time of 3.5 bytes)
ADDR	02H
CMD	10H
High bit of write data	00H
Low bit of write data	04H
High bit of data number	00H
Low bit of data number	02H
Low bit of CRC	C5H
High bit of CRC	6EH
END	T1-T2-T3-T4 (transmission time of 3.5 bytes)

10.4.5 The definition of data address

The address definition of the communication data in this part is to control the running of the inverter and get the state information and related function parameters of the inverter.

10.4.5.1 The rules of parameter address of the function codes

The parameter address occupies 2 bytes with the fact that the high bit is in the front and the low bit is in the behind. The range of high and low byte are: high byte—00–ffH; low byte—00–ffH. The high byte is the group number before the radix point of the function code and the low byte is the number after the radix point. But both the high byte and the low byte should be changed into hex. For example P05.06, the group number before the radix point of the function code is 05, then the high bit of the parameter is 05, the number after the radix point 06, then the low bit of the parameter is 06, then the function code address is 0506H and the parameter address of P10.01 is 0A01H.

Function code	Name	Description	Setting range	Default value	Modification attribute
P10.00	Simple PLC mode	0: Stop after running once; 1: Run at the final value after running once; 2: Cycle running	0–2	0	○
P10.01	Simple PLC memory selection	0: Power loss without memory; 1: Power loss with memory	0–1	0	○

Note: P29 group is the factory parameter which cannot be read or changed. Some parameters cannot be changed when the inverter is in the running state and some parameters cannot be changed in any state. The setting range, unit and related instructions should be paid attention to when modifying the function code parameters.

Besides, EEPROM is stocked frequently, which may shorten the usage time of EEPROM. For users, some functions are not necessary to be stocked on the communication mode. The needs can be met on by changing the value in RAM. Changing the high bit of the function code from 0 to 1 can also realize the function. For example, the function code P00.07 is not stocked into EEPROM. Only by changing the value in RAM can set the address to 8007H. This address can only be used in writing RAM other than reading. If it is used to read, it is an invalid address.

10.4.5.2 The address instruction of other function in Modbus

The master can operate on the parameters of the inverter as well as control the inverter, such as running or stopping and monitoring the working state of the inverter.

Below is the parameter list of other functions:

Function instruction	Address definition	Data meaning instruction	R/W attribute
Communication control command	2000H	0001H: forward running	W/R
		0002H: reverse running	
		0003H: forward jogging	
		0004H: reverse jogging	
		0005H: stop	
		0006H: coast to stop (emergency stop)	
		0007H: fault reset	
		0008H: jogging stop	
Address of communication setting	2001H	Communication setting frequency (0–Fmax (unit: 0.01Hz))	W/R
	2002H	PID given, range (0–1000, 1000 corresponds to100.0%)	
	2003H	PID feedback, range (0–1000, 1000 corresponds to100.0%)	W/R
	2004H	Torque setting value (-3000–3000, 1000 corresponds to	W/R

Function instruction	Address definition	Data meaning instruction	R/W attribute
		the 100.0% of the rated current of the motor)	
	2005H	The upper limit frequency setting during forward rotation (0-Fmax (unit: 0.01Hz))	W/R
	2006H	The upper limit frequency setting during reverse rotation (0-Fmax (unit: 0.01Hz))	W/R
	2007H	The upper limit torque of electromotion torque (0-3000, 1000 corresponds to the 100.0% of the rated current of the motor)	W/R
	2008H	The upper limit torque of braking torque (0-3000, 1000 corresponds to the 100.0% of the rated current of the motor)	W/R
	2009H	Special control command word Bit0-1:=00: motor 1 =01: motor 2 =10: motor 3 =11: motor 4 Bit2:=1 torque control prohibit =0: torque control prohibit invalid Bit3:=1 power consumption clear =0:no power consumption clear Bit4:=1 pre-exciting enabling =0: pre-exciting disabling Bit5:=1 DC braking enabling =0: DC braking disabling	W/R
	200AH	Virtual input terminal command , range: 0x000-0x1FF	W/R
	200BH	Virtual output terminal command , range: 0x00-0x0F	W/R
	200CH	Voltage setting value (special for V/F separation) (0-1000, 1000 corresponds to the 100.0%)	W/R
	200DH	AO output setting 1 (-1000-1000, 1000 corresponds to 100.0%)	W/R
	200EH	AO output setting 2 (-1000-1000, 1000 corresponds to 100.0%)	W/R
SW 1 of the inverter	2100H	0001H: forward running	R
		0002H: reverse running	
		0003H: stop	
		0004H: fault	
		0005H: POFf state	
		0006H: pre-exciting state	
SW 2 of the inverter	2101H	Bit0: =0:ready for operation =1:not ready for operation Bi1-2:=00:motor 1 =01:motor 2	R

Function instruction	Address definition	Data meaning instruction	R/W attribute
		=10: motor 3 =11: motor 4 Bit3: =0: asynchronous motor =1: synchronous motor Bit4: =0: pre-alarm without overload =1: overload pre-alarm Bit5– Bit6: =00: keypad control =01: terminal control =10: communication control	
Fault code of the inverter	2102H	See the fault type instruction	R
Identifying code of the inverter	2103H	UMI-B5 UL-----0x010a	R
Operation frequency	3000H	0–Fmax (unit: 0.01Hz)	R
Setting frequency	3001H	0–Fmax (unit: 0.01Hz)	R
Bus voltage	3002H	0.0–2000.0V (unit: 0.1V)	R
Output voltage	3003H	0–1200V (unit: 1V)	R
Output current	3004H	0.0–3000.0A (unit: 0.1A)	R
Rotation speed	3005H	0–65535 (unit: 1RPM)	R
Output power	3006H	-300.0–300.0% (unit: 0.1%)	R
Output torque	3007H	-250.0–250.0% (unit: 0.1%)	R
Close loop setting	3008H	-100.0–100.0% (unit: 0.1%)	R
Close loop feedback	3009H	-100.0–100.0% (unit: 0.1%)	R
Input IO state	300AH	000–1FF	R
Output IO state	300BH	000–1FF	R
Analog input 1	300CH	0.00–10.00V (unit: 0.01V)	R
Analog input 2	300DH	0.00–10.00V (unit: 0.01V)	R
Analog input 3	300EH	0.00–10.00V (unit: 0.01V)	R
Analog input 4	300FH		R
Read input of high-speed pulse 1	3010H	0.00–50.00kHz (unit: 0.01Hz)	R
Read input of high-speed pulse 2	3011H		R
Read the current stage of multi-step speed	3012H	0–15	R
External length	3013H	0–65535	R
External counting	3014H	0–65535	R

Function instruction	Address definition	Data meaning instruction	R/W attribute
Torque setting	3015H	-300.0–300.0% (unit: 0.1%)	R
Identifying code of the inverter	3016H		R
Fault code	5000H		R

R/W characteristics means the function is with read and write characteristics. For example, “communication control command” is writing characteristics and control the inverter with writing command (06H). R characteristic can only read other than write and W characteristic can only write other than read.

Note: when operate on the inverter with the table above, it is necessary to enable some parameters. For example, the operation of running and stopping, it is necessary to set P00.01 to communication running command channel and set P00.02 to MODBUS communication channel. And when operate on “PID given”, it is necessary to set P09.00 to “MODBUS communication setting”.

The encoding rules for device codes (corresponds to identifying code 2103H of the inverter)

High 8 bit	Meaning	Low 8 bit	Meaning
01	UMI	0x0a	UMI-B5 UL vector inverter

10.4.6 Fieldbus ratio values

The communication data is expressed by hex in actual application and there is no radix point in hex. For example, 50.12Hz cannot be expressed by hex so 50.12 can be magnified by 100 times into 5012, so hex 1394H can be used to express 50.12.

A non-integer can be timed by a multiple to get an integer and the integer can be called fieldbus ratio values.

The fieldbus ratio values are referred to the radix point of the setting range or default value in the function parameter list. If there are figures behind the radix point (n=1), then the fieldbus ratio value m is 10^n . Take the table as the example:

Function code	Name	Description	Setting range	Default value	Modification attribute
P01.20	Wake-up from sleep delay	Setting range: 0.0–3600.0s (valid when P01.19=2)	0.0–3600.0	0.0s	○
P01.21	Restart after power off	0: Disable 1: Enable	0–1	0	○

If there is one figure behind the radix point in the setting range or the default value, then the fieldbus ratio value is 10. if the data received by the upper monitor is 50, then the “hibernation restore delay time” is 5.0 (5.0=50÷10).

If Modbus communication is used to control the hibernation restore delay time as 5.0s. Firstly, 5.0 can be magnified by 10 times to integer 50 (32H) and then this data can be sent.

01 06 01 14 00 32 49 E7

Inverter Write Parameters Data number CRC check
address command address

After the inverter receives the command, it will change 50 into 5 according to the fieldbus ratio value and then set the hibernation restore delay time as 5s.

Another example, after the upper monitor sends the command of reading the parameter of hibernation restore delay time, if the response message of the inverter is as following:

01 03 02 00 32 39 91

Inverter Read 2-byte Parameters CRC check
address command data data

Because the parameter data is 0032H (50) and 50 divided by 10 is 5, then the hibernation restore delay time is 5s.

10.4.7 Fault message response

There may be fault in the communication control. For example, some parameter can only be read. If a writing message is sent, the inverter will return a fault response message.

The fault message is from the inverter to the master, its code and meaning is as below:

Code	Name	Meaning
01H	Illegal command	The command from master cannot be executed. The reason maybe: 1. This command is only for new device; 2. Slave is in fault state and cannot execute it.
02H	Illegal data address	Some of the operation addresses are invalid or not allowed to access. Especially the combination of the register and the transmitting bytes are invalid.
03H	Illegal value	When there are invalid data in the message framed received by slave. Note: This error code does not indicate the data value to write exceed the range, but indicate the message frame is an illegal frame.
04H	Operation failed	The parameter setting in parameter writing is invalid. For example, the function input terminal cannot be set repeatedly.
05H	Password error	The password written to the password check address is not same as the password set by P7.00.
06H	Data frame error	In the frame message sent by the upper monitor, the length of the digital frame is incorrect or the counting of CRC check bit in RTU is different from the lower monitor.
07H	Parameters only for read	It only happen in write command
08H	Parameters cannot be	The modified parameter in the writing of the upper monitor cannot be modified during running.

Code	Name	Meaning
	changed during running	
09H	Password protection	When the upper monitor is writing or reading and the user password is set without password unlocking, it will report that the system is locked.

The slave uses functional code fields and fault addresses to indicate it is a normal response or some error occurs (named as objection response). For normal responses, the slave shows corresponding function codes, digital address or sub-function codes as the response. For objection responses, the slave returns a code which equals the normal code, but the first byte is logic 1.

For example: when the master sends a message to the slave, requiring it to read a group of address data of the inverter function codes, there will be following function codes:

0 0 0 0 0 1 1 (Hex 03H)

For normal responses, the slave responds the same codes, while for objection responses, it will return:

1 0 0 0 0 1 1 (Hex 83H)

Besides the function codes modification for the objection fault, the slave will respond a byte of abnormal code which defines the error reason.

When the master receives the response for the objection, in a typical processing, it will send the message again or modify the corresponding order.

For example, set the "running command channel" of the inverter (P00.01, parameter address is 0001H) with the address of 01H to 03, the command is as following:

01 **06** **00 01** **00 03** **98 0B**
 Inverter Write Parameters Parameters CRC check
 address command address data

But the setting range of "running command channel" is 0–2, if it is set to 3, because the number is beyond the range, the inverter will return fault response message as below:

01 **86** **04** **43 A3**
 Inverter Abnormal Fault code CRC check
 address response code
 code

Abnormal response code 86H means the abnormal response to writing command 06H; the fault code is 04H. In the table above, its name is operation failed and its meaning is that the parameter setting in parameter writing is invalid. For example, the function input terminal cannot be set repeatedly.

10.4.8 Example of writing and reading

Refer to 10.4.1 and 10.4.2 for the command format.

10.4.8.1 Example of reading command 03H

Read the state word 1 of the inverter with the address of 01H (refer to table 1). From the table 1, the

parameter address of the state word 1 of the inverter is 2100H.

The command sent to the inverter:

01 03 21 00 00 01 8E 36
 Inverter Read Parameters Data number CRC check
 address command address

If the response message is as below:

01 03 02 00 03 F8 45
 Inverter Read Parameters Data number CRC check
 address command address

The data content is 0003H. From the table 1, the inverter stops.

Watch “Type of the present fault” to “Type of the last but four fault” of the inverter through commands, the corresponding function code is P07.27–P07.32 and corresponding parameter address is 071BH–0720H (there are 6 from 071BH).

The command sent to the inverter:

03 03 07 1B 00 06 B5 59
 Inverter Read Starting 6 CRC check
 address command address parameters

If the response message is as below:

03 03 0C 00 23 00 23 00 23 00 23 00 23 00 23 5F D2
 Inverter Read Byte Type of Type of the Type of the Type of the Type of the Type of the Type of the CRC check
 address command number present fault last fault last but one last but two last but three last but four

See from the returned data, all fault types are 0023H (decimal 35) with the meaning of maladjustment (STo).

10.4.8.2 Example of writing command 06H

Make the inverter with the address of 03H to run forward. See table 1, the address of “communication control command” is 2000H and forward running is 0001. See the table below.

Function instruction	Address definition	Data meaning instruction	R/W characteristics
Communication control command		0001H: forward running	W/R
		0002H: reverse running	
		0003H: forward jogging	
		0004H: reverse jogging	
		0005H: stop	
		0006H: coast to stop (emergency stop)	
		0007H: fault reset	
		0008H: jogging stop	

The command sent by the master:

03 **06** **20 00** **00 01** **42 28**
 Inverter Write Parameters Forward CRC
 address command address running check

If the operation is success, the response may be as below (the same with the command sent by the master):

03 **06** **20 00** **00 01** **42 28**
 Inverter Write Parameters Forward CRC
 address command address running check

Set the max Output frequency of the inverter with the address of 03H as100Hz.

P00.03	Max. output frequency	Setting range: P00.04–400.00Hz (400.00Hz)	10.00–400.00	60.00Hz	⊙
--------	-----------------------	--	--------------	---------	---

See the figures behind the radix point, the fieldbus ratio value of the max output frequency (P00.03) is 100. 100Hz timed by 100 is 10000 and the corresponding hex is 2710H.

The command sent by the master:

03 **06** **00 03** **27 10** **62 14**
 Inverter Write Parameters Parameters CRC
 address command address data check

If the operation is successful, the response may be as below (the same with the command sent by the master):

03 **06** **00 03** **27 10** **62 14**
 Inverter Write Parameters Parameters CRC
 address command address data check

Note: The blank in the above command is for illustration. The blank cannot be added in the actual application unless the upper monitor can remove the blank by themselves.

10.4.8.3 Example of continuous writing command 10H

Example 1: make the inverter whose address is 01H run forward at 10Hz. Refer to the instruction of 2000H and 0001. Set the address of “communication setting frequency” is 2001H and 10Hz corresponds to 03E8H. See the table below.

Function instruction	Address definition	Data meaning instruction	R/W attribute
Communication control command	2000H	0001H: forward running	W/R
		0002H: reverse running	
		0003H: forward jogging	
		0004H: reverse jogging	
		0005H: stop	
		0006H: coast to stop (emergency stop)	
		0007H: fault reset	
		0008H: jogging stop	

Function instruction	Address definition	Data meaning instruction	R/W attribute
The address of communication setting	2001H	Communication setting frequency (0–Fmax (unit: 0.01Hz))	W/R
	2002H	PID given, range (0–1000, 1000 corresponds to100.0%)	

Set P00.01 to 2 and P00.06 to 8.

The command sent to the inverter:

01 10 20 00 00 02 04 00 01 03 E8 3B 10
 Inverter address Continuous writing command Parameters address Data number Byte number Forward running 10Hz CRC check

If the response message is as below:

01 10 20 00 00 02 4A 08
 Inverter address Continuous writing command Parameters address Data number CRC check

Example 2: set the ACC time of 01H inverter as 10s and the DEC time as 20s

P00.11	ACC time 1	ACC time means the time needed if the inverter speeds up from 0Hz to the max One (P00.03).	Depend on model	○
P00.12	DEC time 1	DEC time means the time needed if the inverter speeds down from the max Output frequency to 0Hz (P00.03). UMI-B5 UL series inverters define four groups of ACC/DEC time which can be selected by P05. The factory default ACC/DEC time of the inverter is the first group. Setting range of P00.11 and P00.12: 0.0–3600.0s	Depend on model	○

The corresponding address of P00.11 is 000B, the ACC time of 10s corresponds to 0064H, and the DEC time of 20s corresponds to 00C8H.

The command sent to the inverter:

01 10 00 0B 00 02 04 00 64 00 C8 F2 55
 Inverter address Continuous writing command Parameters address Data number Byte number 10s 20s CRC check

If the response message is as below:

01 10 00 0B 00 02 30 0A
 Inverter address Continuous writing command Parameters address Data number CRC check

Note: The space between above commands is for instruction and there is no space between the commands during actual applications.

10.5 Common communication fault

Common communication faults: no response to the communication or the inverter returns abnormal fault.

The possible reason for no response to the communication:

Selecting wrong serial interface, for example, if the converter is COM1, selecting COM2 during the communication

The baud rate, digital bit, end bit and check bit are not the same with the inverter + and - of RS485 are connected in reverse.

The 485 wire cap on the terminal board of the inverter is not plug in. the wire cap in behind the terminal arrangement.

Appendix A Technical data

A.1 What this chapter contains

This chapter contains the technical specifications of the inverter, as well as provisions for fulfilling the requirements for CE, UL, CUL and other marks.

A.2 Ratings

A.2.1 Capacity

Inverter sizing is based on the rated motor current and power. To achieve the rated motor power given in the table, the rated current of the inverter must be higher than or equal to the rated motor current. Also the rated power of the inverter must be higher than or equal to the rated motor power. The power ratings are the same regardless of the supply voltage within one voltage range.

Note:

1. The maximum allowed motor shaft power is limited to 1.5·PN. If the limit is exceeded, motor torque and current are automatically restricted. The function protects the input bridge of the drive against overload.
2. The ratings apply at ambient temperature of 40°C
3. It is important to check that in Common DC systems the power flowing through the common DC connection does not exceed PN.

A.2.2 Derating

The load capacity decreases if the installation site ambient temperature exceeds 40°C, the altitude exceeds 3281ft (1000m) or the switching frequency is changed from 4kHz to 8, 12 or 15kHz.

A.2.2.1 Temperature derating

The usage temperature range is 14–104°F (-10°C–40°C). If the ambient temperature of the inverter is above 104°F (40°C), it is necessary to derate. The maximum ambient temperature is 122°F (50°C). Refer to the below list for the actual derating.

Power (kW)	Horse power (HP)	Temperature and derating coefficient										
		104°F (40°C)	105.8 °F (41°C)	107.6 °F (42°C)	109.4 °F (43°C)	111.2°F (44°C)	113°F (45°C)	114.8 °F (46°C)	116.6 °F (47°C)	118.4 °F (48°C)	120.2 °F (49°C)	122°F (50°C)
1.5	2	100%	100%	100%	100%	100%	100%	99%	98%	97%	96%	95%
2.2	3	100%	99%	98%	97%	96%	95%	94%	93%	92%	91%	90%
4	5	100%	100%	100%	100%	100%	100%	99%	98%	97%	96%	95%
5.5	7.5	100%	99%	98%	97%	96%	95%	94%	93%	92%	91%	90%
7.5	10	100%	100%	100%	100%	100%	100%	99%	98%	97%	96%	95%
11	15	100%	99%	98%	97%	96%	95%	94%	93%	92%	91%	90%
15	20	100%	100%	100%	100%	100%	100%	99%	98%	97%	96%	95%

Power	Horse power	Temperature and derating coefficient										
		100%	99%	98%	97%	96%	95%	94%	93%	92%	91%	90%
18.5	25	100%	99%	98%	97%	96%	95%	94%	93%	92%	91%	90%
22	30	100%	100%	100%	100%	100%	100%	99%	98%	97%	96%	95%
30	40	100%	99%	98%	97%	96%	95%	94%	93%	92%	91%	90%
37	50	100%	100%	100%	100%	100%	100%	99%	98%	97%	96%	95%
45	60	100%	100%	100%	99%	98%	97%	96%	95%	94%	93%	92%
55	75	100%	99%	98%	97%	96%	95%	94%	93%	92%	91%	90%

Below is the derating curve of the big-power inverters:

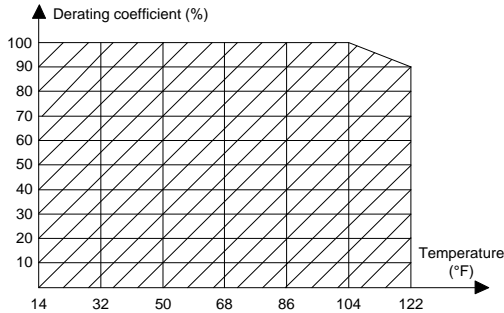

A.2.2.2 Altitude derating

The device can output rated power if the installation site below 3281ft (1000m). The output power decreases if the altitude exceeds 3281ft (1000m). Below is the detailed decreasing range of the derating:

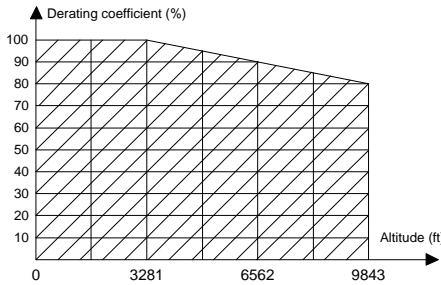

For 3-phase 200V drives, the maximum altitude is 9843ft (3000m) above sea level. In altitudes 6562...9843ft (2000...3000m), the derating is 1% for every 328ft (100m).

A.2.2.3 Carrier frequency derating

For UMI-B5 UL series inverters, different power level corresponds to different carrier frequency range. The rated power of the inverter is based on the factory carrier frequency, so if it is above the factory value, the inverter needs to derate.

Power (HP)	Carrier frequency and derating coefficient													
	2kHz	3kHz	4kHz	5kHz	6kHz	7kHz	8kHz	9kHz	10kHz	11kHz	12kHz	13kHz	14kHz	15kHz
2	100%	100%	100%	100%	100%	100%	100%	100%	96%	93%	90%	87%	85%	83%
3	100%	100%	100%	100%	100%	100%	100%	98%	95%	92%	89%	86%	83%	81%
5	100%	100%	100%	100%	100%	100%	100%	100%	96%	92%	89%	86%	83%	80%
7.5	100%	100%	100%	100%	100%	100%	100%	97%	93%	90%	87%	84%	81%	79%
10	100%	100%	100%	100%	100%	100%	100%	100%	95%	91%	87%	84%	81%	79%
15	100%	100%	100%	100%	100%	100%	100%	96%	92%	88%	84%	80%	77%	74%
20	100%	100%	100%	100%	95%	91%	87%	83%	79%	75%	71%	/	/	/
25	100%	100%	100%	96%	92%	88%	84%	81%	77%	74%	70%	/	/	/
30	100%	100%	100%	100%	100%	94%	87%	80%	74%	68%	64%	/	/	/
40	100%	100%	100%	95%	90%	80%	75%	70%	66%	62%	58%	/	/	/
50	100%	100%	100%	100%	100%	95%	90%	86%	82%	78%	74%	/	/	/
60	100%	100%	100%	100%	95%	90%	85%	81%	77%	73%	69%	/	/	/
75	100%	100%	100%	96%	91%	86%	81%	77%	73%	69%	65%	/	/	/

A.3 Grid specifications

Grid voltage	AC 3PH 380V–480V
Allowable voltage fluctuation	-15%–10%
Frequency	50/60Hz±5%, maximum rate of change 20%/s

A.4 Motor connection data

Motor type	Asynchronous induction motor or synchronous permanent magnet motor
Voltage	0 to U1, 3-phase symmetrical, Umax at the field weakening point
Short-circuit protection	The motor output is short-circuit proof by IEC 61800-5-1
Frequency	0...400Hz
Frequency resolution	0.01Hz
Current	Refer to Ratings
Power limit	1.5·PN
Field weakening point	10...400Hz
Carrier frequency	4, 8, 12 or 15kHz

A.4.1 EMC compatibility and motor cable length

To comply with the European EMC Directive (standard IEC/EN 61800-3), use the following maximum motor cable lengths for 4kHz switching frequency.

All frame sizes (with external EMC filter)	Maximum motor cable length, 4kHz
Second environment (category C3)	30
First environment (category C2)	30

Maximum motor cable length is determined by the drive's operational factors. Contact the local representative for the exact maximum lengths when using external EMC filters.

A.5 Applicable standards

The inverter complies with the following standards:

EN ISO 13849-1: 2008	Safety of machinery-safety related parts of control systems - Part 1: general principles for design
IEC/EN 60204-1:2006	Safety of machinery. Electrical equipment of machines. Part 1: General requirements.
IEC/EN 62061: 2005	Safety of machinery – Functional safety of safety-related electrical, electronic and programmable electronic control systems
IEC/EN 61800-3:2004	Adjustable speed electrical power drive systems. Part 3: EMC requirements and specific test methods
IEC/EN 61800-5-1:2007	Adjustable speed electrical power drive systems – Part 5-1: Safety requirements – Electrical, thermal and energy
IEC/EN 61800-5-2:2007	Adjustable speed electrical power drive systems – Part 5-2: Safety requirements. Functional.
UL 508C	Power conversion equipment, 3rd edition.
C22.2 No. 274-13	Adjustable speed drives, 1st edition.

A.5.1 CE marking

The CE mark is attached to the drive to verify that the drive follows the provisions of the European Low Voltage and EMC Directives.

A.5.2 UL and CUL marking

The UL and CUL marks are attached to the drive to verify that the drive follows the provisions of the UL508C and C22.2 No. 274-13.

A.5.3 Compliance with the European EMC Directive

The EMC Directive defines the requirements for immunity and emissions of electrical equipment used within the European Union. The EMC product standard (EN 61800-3:2004) covers requirements stated for drives. See section *EMC regulations*

A.6 EMC regulations

EMC product standard (EN 61800-3:2004) contains the EMC requirements to the inverter.

First environment: domestic environment (includes establishments connected to a low-voltage network which supplies buildings used for domestic purposes).

Second environment includes establishments connected to a network not directly supplying domestic premises.

Four categories of the inverter:

Inverter of category C1: inverter of rated voltage less than 1000 V and used in the first environment.

Inverter of category C2: inverter of rated voltage less than 1000 V other than pins, sockets and motion devices and intended to be installed and modulated only by a professional electrician when used in the first environment.

Note: IEC/EN 61800-3 in EMC standard doesn't limit the power distribution of the inverter, but it

defines the usage, installation and commissioning. The professional electrician has necessary skills in installing and/or commissioning power drive systems, including their EMC aspects.

Inverter of category C3: inverter of rated voltage less than 1000 V and used in the second environment other than the first one

Inverter of category C4: inverter of rated voltage more than 1000 V or the nominal current is above or equal to 400A and used in the complicated system in second environment

A.6.1 Category C2

The emission limits are complied with the following provisions:

1. The optional EMC filter is selected according to the options and installed as specified in the EMC filter manual.
2. The motor and control cables are selected as specified in this manual.
3. The drive is installed according to the instructions given in this manual.
4. For the maximum motor cable length with 4kHz switching frequency, see **EMC compatibility and motor cable length**.

	⚡ In a domestic environment, this product may cause radio inference, in which case supplementary mitigation measures may be required.
---	---

A.6.2 Category C3

The immunity performance of the drive complies with the demands of IEC/EN 61800-3, second environment.

The emission limits are complied with the following provisions:

1. The optional EMC filter is selected according to the options and installed as specified in the EMC filter manual.
2. The motor and control cables are selected as specified in this manual.
3. The drive is installed according to the instructions given in this manual.
4. For the maximum motor cable length with 4 kHz switching frequency, see **EMC compatibility and motor cable length**.

	⚡ A drive of category C3 is not intended to be used on a low-voltage public network which supplies domestic premises. Radio frequency interference is expected if the drive is used on such a network.
---	--

Appendix B Dimension drawings

B.1 What this chapter contains

Dimension drawings of the UMI-B5 UL are shown below. The dimensions are given in millimeters and inches.

B.2 Keypad structure

B.2.1 Structure chart

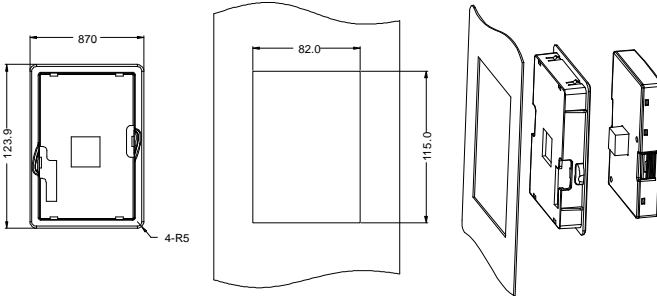

C.2.2 Installation bracket (optional)

Note: It is necessary to use M3 screw or installation bracket to fix the external keypad. The installation bracket for inverters of 220V, 1–20HP (0.75–15kW) and 460V, 2–40HP (1.5–30kW) is optional but it is standard for the inverters of 220V, 25–75HP (18.5–55kW) and 460V, 50–150HP (37–110kW).

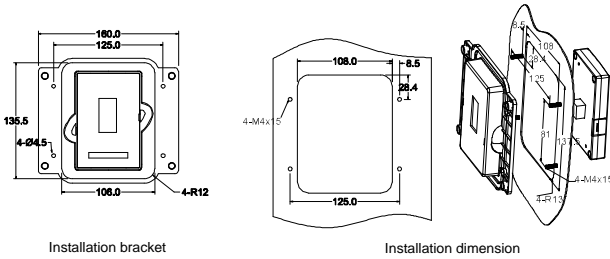

B.3 Inverter structure

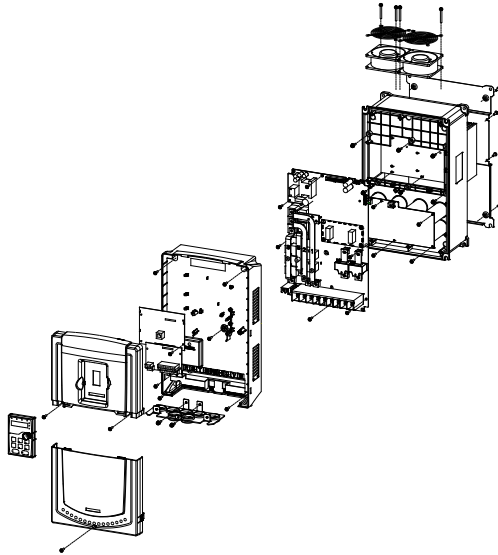

B.4 Dimensions for inverters

B.4.1 Wall installation

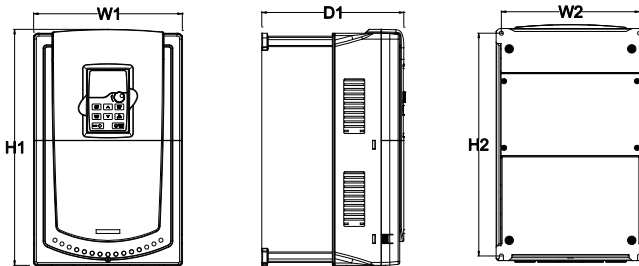

Wall installation of inverters of 220V, 1–20HP (0.75–15kW) and 460V, 2–40HP (1.5–30kW)

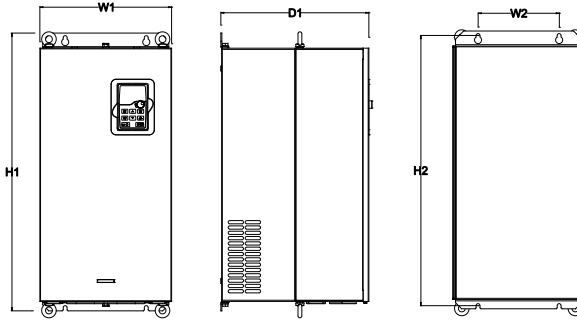

Wall installation of inverters of 220V, 25–75HP (18.5–55kW) and 460V, 50–150HP (37–110kW)

Appendix C Further information

C.1 Product and service inquiries

Address any inquiries about the product to your local UNITRONICS offices, quoting the type designation and serial number of the unit in question.



International Sales: global.sales@unitronics.com
USA Sales: usa.sales@unitronics.com
Technical support: support@unitronics.com



DOC31003-A1

The information in this document reflects products at the date of printing. Unitronics reserves the right, subject to all applicable laws, at any time, at its sole discretion, and without notice, to discontinue or change the features, designs, materials and other specifications of its products, and to either permanently or temporarily withdraw any of the forgoing from the market.

All information in this document is provided "as is" without warranty of any kind, either expressed or implied, including but not limited to any implied warranties of merchantability, fitness for a particular purpose, or non-infringement. Unitronics assumes no responsibility for errors or omissions in the information presented in this document. In no event shall Unitronics be liable for any special, incidental, indirect or consequential damages of any kind, or any damages whatsoever arising out of or in connection with the use or performance of this information.

The tradenames, trademarks, logos and service marks presented in this document, including their design, are the property of Unitronics (1989) (R"G) Ltd. or other third parties and you are not permitted to use them without the prior written consent of Unitronics or such third party as may own them.